

# Cone Giratório

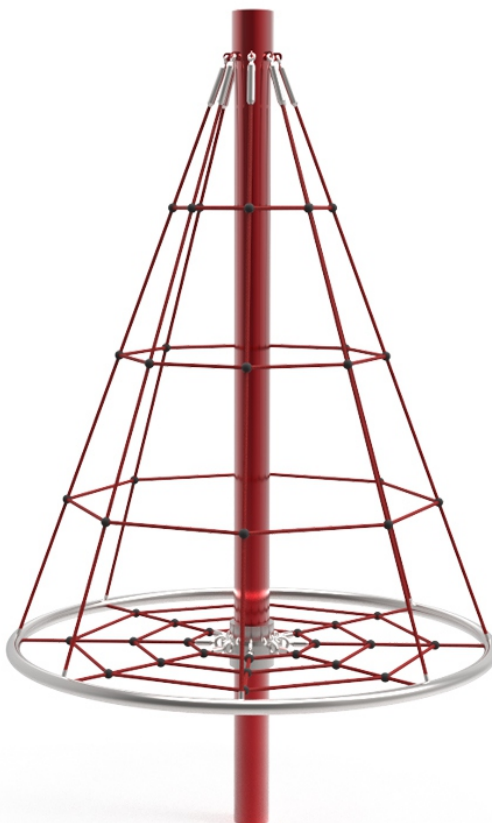

ref. B0100101



**+2 ANOS**

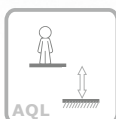

**2.25 m**

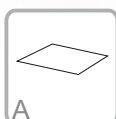

**29 m<sup>2</sup>**

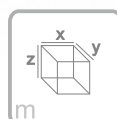

**xy=ø2.00  
z=3.00**

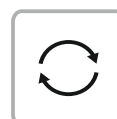

**360°**

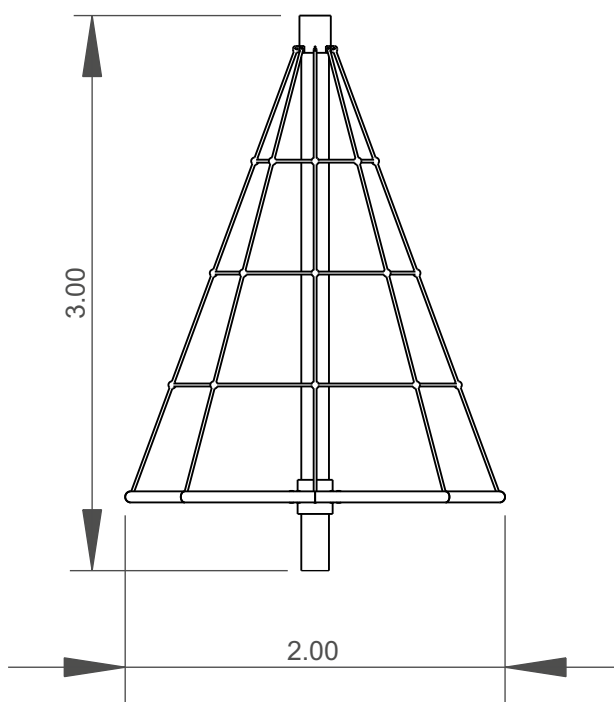

Utilização do equipamento sujeito a condições vigiadas;  
Zona de segurança: Área mínima requerida pela norma EN 1176-1;

Ficha Técnica

# Informação do Equipamento:

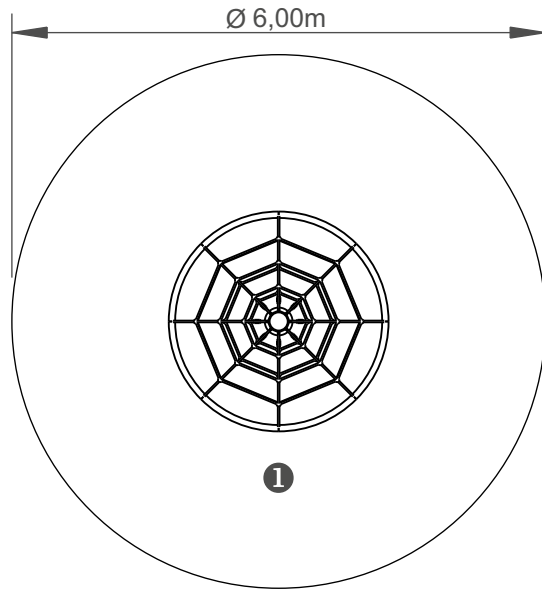



— Zona de impacto

- - Espaço livre

EN 1176-1



.....	1
	2.25
	29
	29

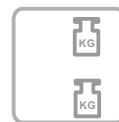
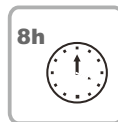
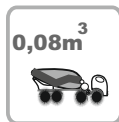

# Informação Técnica:

1 - Cone Giratório  2.25m

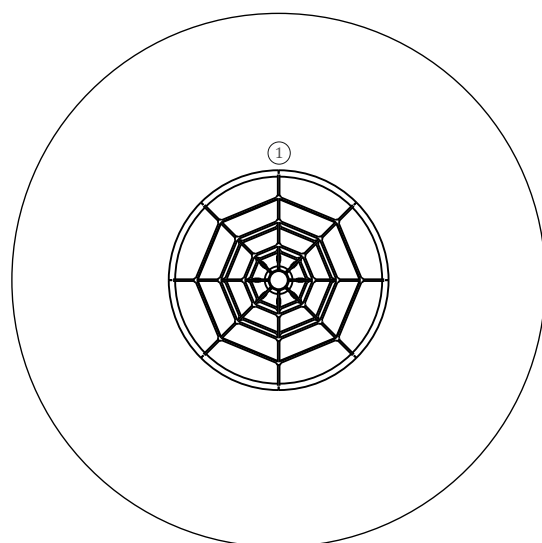

## Características Técnicas:

**Rede:** cordas Ø16mm reforçadas em aço revestido por fibras de polipropileno, acessórios de ligação e fixação em plástico HDPE com protecção U.V., elementos de fixação em aço galvanizado a quente;

### Peças Metálicas

**Prumo:** Aço Inox AISI 304;

### Sistema de fixação:

**Tipo C - Sistema de fixação** standard composto por prumo aplicado directamente no solo e chumbado com betão;

### Parafusos e acessórios

**Parafusos:** Aço zincado ou opcionalmente aço inox AISI 304;

**Cápsulas:** Plástico polipropileno PP;



100% reciclável;



## Funções Lúdicas:



**Divertir:** Enquanto se divertem, as crianças adquirem imensas capacidades, desde habilidades físicas a interações sociais.



**Socializar:** A socialização e a imaginação são necessárias em todo o jogo. Tudo isso cria relação entre crianças e desperta o senso de convivência e a solidariedade.



**Jogar:** Desenvolve a paciência, a partilha e o espírito desportivo.



**Trepar:** Desenvolve as capacidades motrizes das crianças, o controlo do próprio corpo, o equilíbrio e a coordenação, estimulando a capacidade motora e a força nos movimentos.