

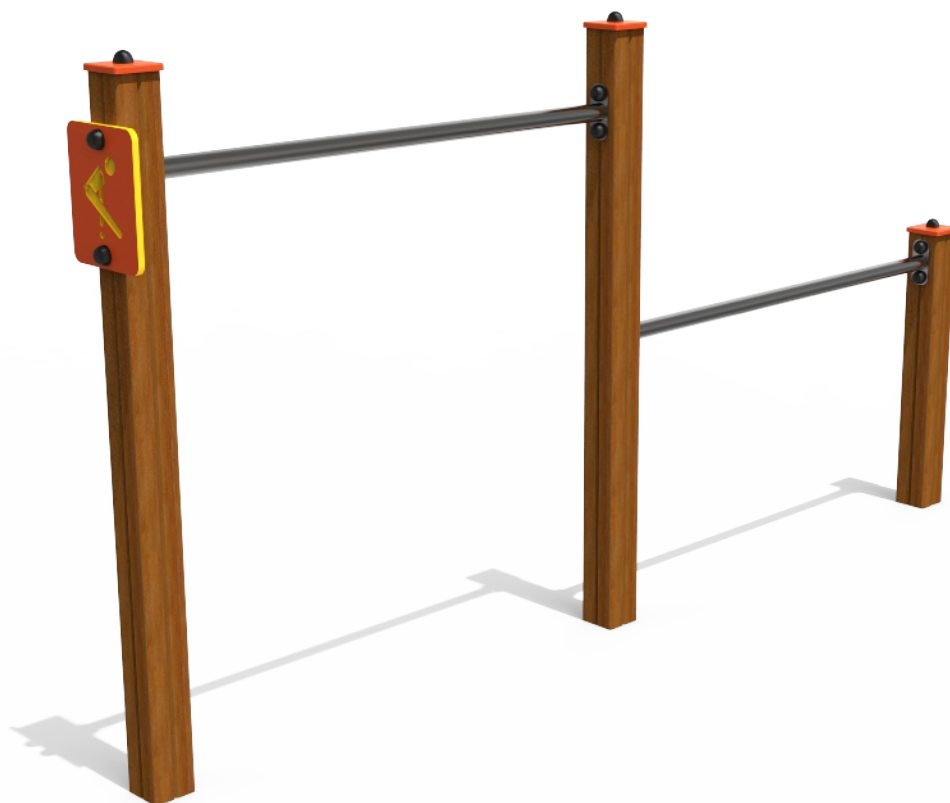



SALTO EM APOIO

BCM005-A



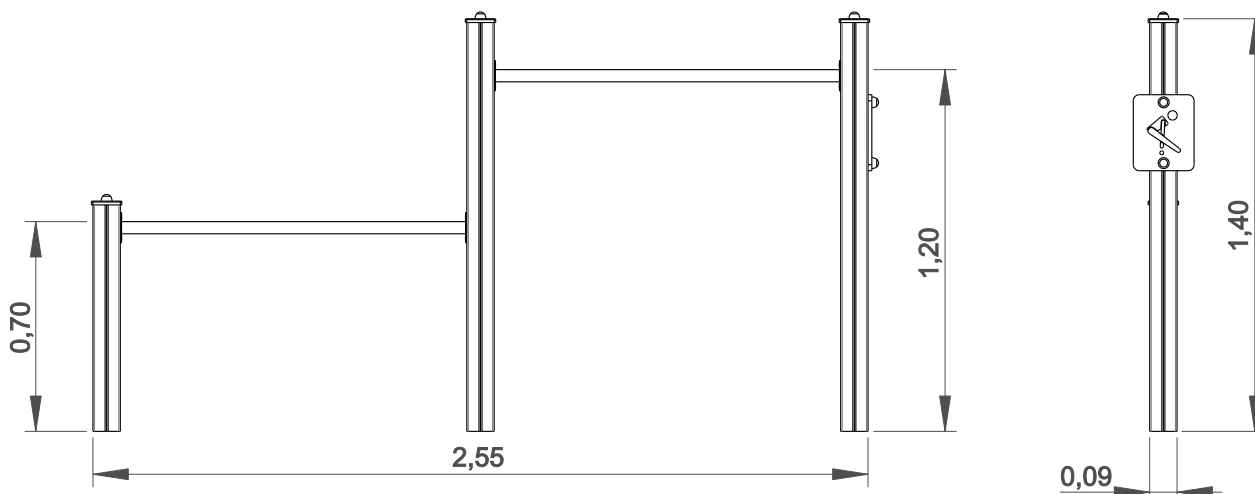

			
17m ²	1.20m	+6	2



Utilização do equipamento sujeito a condições vigiadas; Zona de segurança: Área mínima requerida pela norma EN 1176-1,6
 Utilización del equipo sujeto a condiciones vigiladas; Zona de seguridad: Área mínima requerida por la norma EN 1176-1,6
 Use of equipment subject to supervised conditions; Safety zone: Minimum area required by EN 1176-1,6
 Utilisation d'équipement soumis à des conditions supervisées; Zone de sécurité: Surface minimale requise par l'EN 1176-1,6

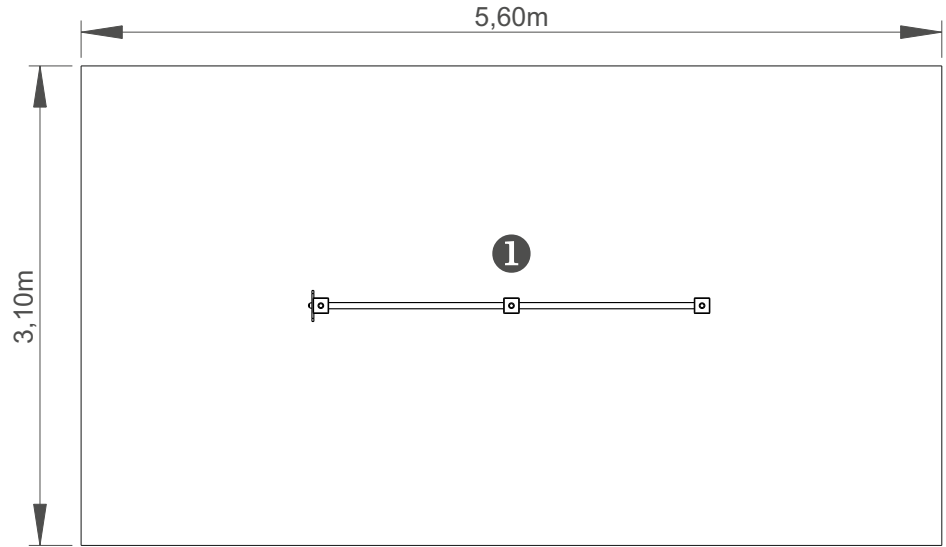



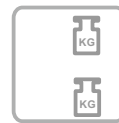

.....	①
	1,20
	17
	17



INFORMAÇÃO TÉCNICA / INFORMACIÓN TÉCNICA / TECHNICAL INFORMATION / INFORMATIONS TECHNIQUES

- 1 - Salto em Apoio  1.20m
- 2 - Salto em Apoio  0.70m

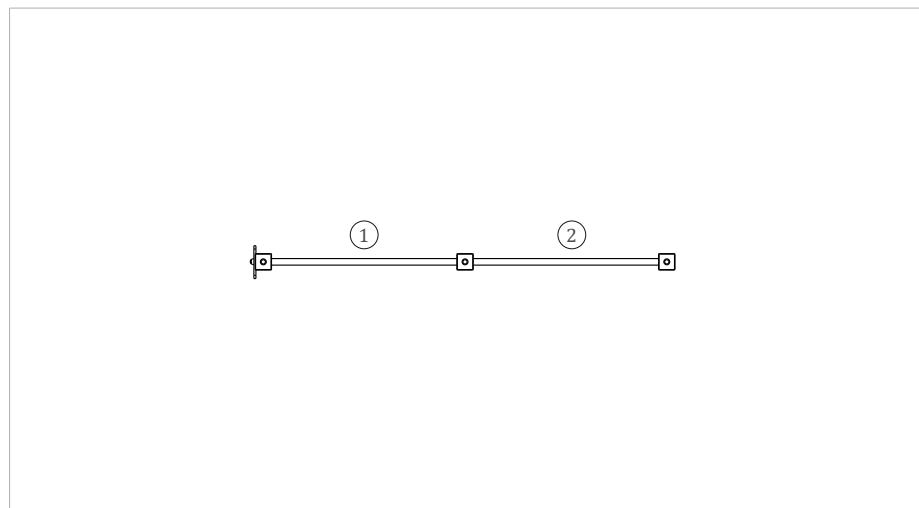



Prumos

Madeira: Pinho laminado classificado com qualidade de garantia por controlo interno contínuo. Com tratamento autoclave, protegendo-a dos ataques de cogumelos, insectos e térmites. Acabamento final a tinta de base aquosa especialmente desenvolvida para proteger a madeira de humidades, intempéries e raios U.V.. Contém princípios activos que lhe conferem uma barreira protetora contra o aparecimento de fungos e bolores;

Painéis

HDPE: Polietileno de alta densidade monocolor ou bicolor. Por ser um polímero é caracterizado pela sua resistência a produtos químicos e à corrosão. Pela sua capacidade de elasticidade e leveza, oferece alta resistência ao impacto, sendo muito difícil quebrar. A sua base sintética impede o cultivo de bactérias e fungos. Não necessita de qualquer manutenção;

Peças Metálicas

Tubos: Aço Inox AISI 304 de Ø40mm;

Sistema de fixação

Tipo A – Sistema de fixação standard composto por base metálica embutida no solo e chumbada com betão;

Parafusos e acessórios

Parafusos: Aço zincado ou opcionalmente aço inox AISI 304;

Câpsulas: Plástico polipropileno PP;



PROTECTORES DECORATIVOS:



Penetra profundamente na madeira destacando os veios e embelezando a madeira com as suas cores especiais transparentes.



Muito resistente ao sol. Contém pigmentos micronizados absorventes e estabilizadores dos raios U.V.



Microporos, deixa respirar a madeira e evita as deformações naturais da madeira.

PRINCÍPIOS ACTIVOS



Fácil manutenção. Não é necessário lixar ou decapar para a aplicação de novas camadas.



Conferindo ao filme uma barreira protectora contra fungos e bolores.



HIDRÓFUGO
protege contra a humidade, a chuva e impermeabiliza.





Postes

Madera: Pino laminado clasificado con calidad de garantía por control interno continuo. Con tratamiento autoclave, protegiéndola de los ataques de setas, insectos y termitas. Acabado final a tinta de base acuosa especialmente desarrollada para proteger la madera de humedad, intemperie y rayos U.V .. Contiene principios activos que le confieren una barrera protectora contra la aparición de hongos y mohos;

paneles

HDPE: Polietileno de alta densidad monocolor o bicolor. Por ser un polímero se caracteriza por su resistencia a los productos químicos ya la corrosión. Por su capacidad de elasticidad y ligereza, ofrece alta resistencia al impacto, siendo muy difícil romper. Su base sintética impide el cultivo de bacterias y hongos. No necesita mantenimiento;

Piezas Metálicas

Tubos: Acero Inox AISI 304 de Ø40mm;

Sistema de fijación

Tipo A – Sistema de fijación estándar compuesto por base metálica embutida en el suelo y plomada con hormigón;

Tornillos y accesorios

Tornillos: Acero zincado o opcionalmente acero inoxidable AISI 304;
Câpsulas: Plástico polipropileno PP;



PROTECTORES DECORATIVOS:



Penetra profundamente na madeira destacando os veios e embelezando a madeira com as suas cores especiais transparentes



Muito resistente ao sol. Contém pigmentos micronizados absorventes e estabilizadores dos raios U.V.



Microporos, deixa respirar a madeira e evita as deformações naturais da madeira.



PRINCÍPIOS ACTIVOS
Conferindo ao filme uma barreira protectora contra fungos e bolores



HIDRÓFUGO
protege contra a humidade, a chuva e impermeabiliza.



SISTEMAS DE FIXAÇÃO / SISTEMAS DE FIJACIÓN
FIXING SYSTEMS / SYSTÈMES DE FIXATION



Plums

Wood: Laminated pine classified with guarantee quality by continuous internal control. With autoclave treatment, protecting it from attacks of mushrooms, insects and termites. Water-based paint finish specially developed to protect wood from moisture, weather and U.V. rays. Contains active principles that give it a protective barrier against the appearance of fungi and molds;

Panels

HDPE: High density polyethylene mono or two color. Being a polymer is characterized by its resistance to chemicals and corrosion. Due to its elasticity and lightness, it offers high impact resistance and is very difficult to break. Its synthetic base prevents the cultivation of bacteria and fungi. It does not require any maintenance;

Metal parts

Pipes: Stainless steel AISI 304 Ø40mm;

Fixation System

Type A – Standard fixing system composed of metal base embedded in the ground and cast with concrete;

Screws and accessories

Screws: Zinc-plated steel or optionally AISI 304 stainless steel;

Capsules: PP polypropylene plastic;



PROTECTORES DECORATIVOS:



Penetra profundamente na madeira destacando os veios e embelezando a madeira com as suas cores especiais transparentes



Fácil manutenção. Não é necessário lixar ou decapar para a aplicação de novas camadas.



Muito resistente ao sol. Contém pigmentos micronizados absorventes e estabilizadores dos raios U.V.



PRINCÍPIOS ACTIVOS
Conferindo ao filme uma barreira protectora contra fungos e bolores



Microporoso, deixa respirar a madeira e evita as deformações naturais da madeira.



HIDRÓFUGO
protege contra a humidade, a chuva e impermeabiliza.



Poteaux

Bois: Pin stratifié classé avec une qualité garantie par contrôle interne continu. Avec traitement autoclave, le protégeant des attaques de champignons, d'insectes et de termites. Finition de peinture à base d'eau spécialement développée pour protéger le bois contre l'humidité, les intempéries et les rayons UV. Contient des principes actifs qui lui confèrent une barrière protectrice contre l'apparition de champignons et de moisissures;

Panneaux

HDPE: Polyéthylène haute densité mono ou bicolore. Être un polymère se caractérise par sa résistance aux produits chimiques et à la corrosion. Grâce à son élasticité et à sa légèreté, il offre une grande résistance aux chocs et est très difficile à briser. Sa base synthétique empêche la culture de bactéries et de champignons. Il ne nécessite aucun entretien

Pièces métalliques

Tuyaux: acier inoxydable AISI 304 Ø40mm;

Système de fixation

Type A – Système de fixation standard composé d'une base en métal noyée dans le sol et coulée avec du béton;

Vis et accessoires

Vis: Acier zingué ou acier inoxydable AISI 304 en option;

Capsules: PP polypropylène plastique;



100%

PROTECTORES DECORATIVOS:



Penetra profundamente na madeira destacando os veios e embelezando a madeira com as suas cores especiais transparentes



Muito resistente ao sol. Contém pigmentos micronizados absorventes e estabilizadores dos raios UV.



Microporos, deixa respirar a madeira e evita as deformações naturais da madeira.



Fácil manutenção. Não é necessário lixar ou decapar para a aplicação de novas camadas.



PRINCÍPIOS ACTIVOS
Conferindo ao filme uma barreira protectora contra fungos e bolores



HIDRÓFUGO
protege contra a humidade, a chuva e impermeabiliza.

