

BriCANTEL[®]

Soluções em espaços urbanos

Luminária Solar

BRFX



Economia



Qualidade



Alto Brilho



5-7 Dias



Sensor



Controlo Remoto



Suporte Ajustável



IP65

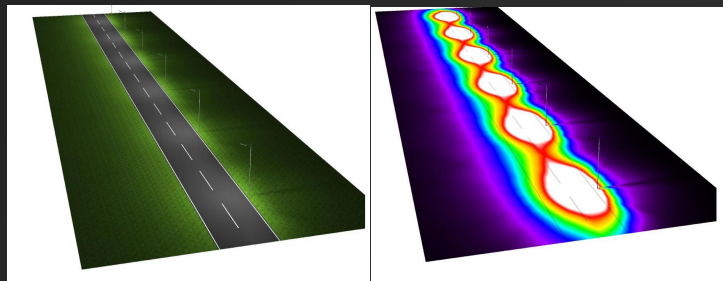
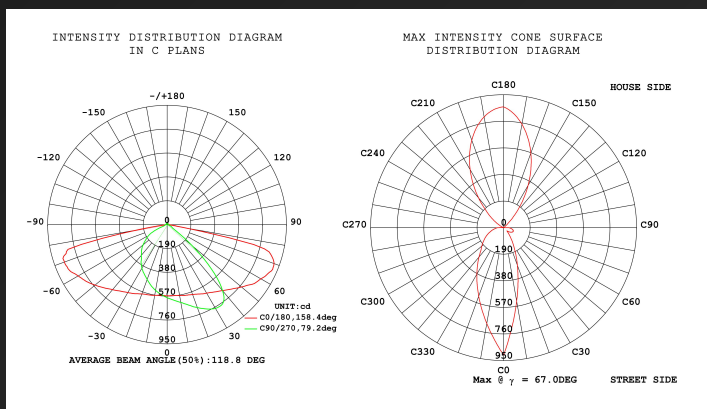

Instalação vertical

Instalação horizontal

ITEM	BRFX40W	BRFX50W	BRFX60W	BRFX80W	BRFX100W	BRFX120W
Painel Solar	18V 65W	18V 70W	18V 80W	18V 100W	18V 130W	18V 140W
Bateria LiFePO4	12.8V 30AH	12.8V 36AH	12.8V 48AH	12.8V 54AH	12.8V 66AH	12.8V 72AH
LEDs (Bridgelux)	3030/96PCS	3030/144PCS	3030/144PCS	3030/192PCS	3030/288PCS	3030/288PCS
CCT	2700K-6500K, RA>70					
Eficiência Luminosa	220LM/W					
Tempo Trabalho	12-15 horas					
Tempo Carga	6-8 horas					
Diâmetro Instalação	70-76mm					
Temperatura Operação	-25°C - +65°C					
Sensor	160°, >9m					
Indicador de nível da bateria	100%-75%-50%-25%					
Indicador de falha	Vermelho/Azul/Verde					
Índice Protecção	IP66/IK09					
Altura de montagem	6-7m	6-8m	6-8m	8-9m	9-11m	10-12m
Espaçamento entre luminárias	20-25m	20-25m	20-25m	25-30m	30-35m	35-40m
Garantia	3 Anos					

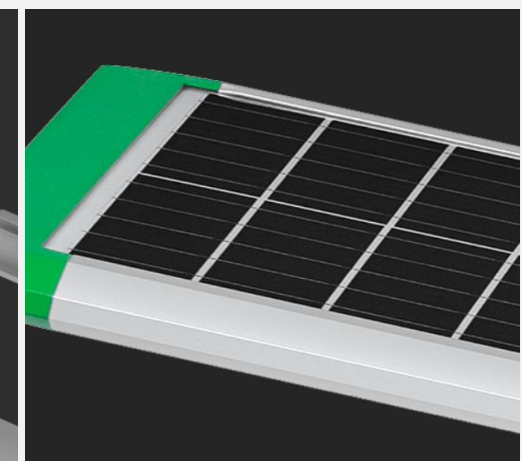
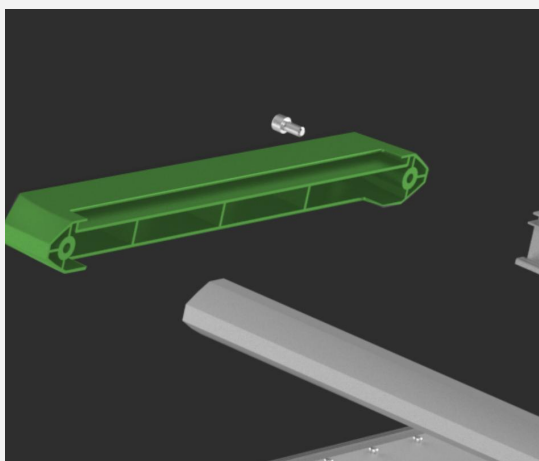
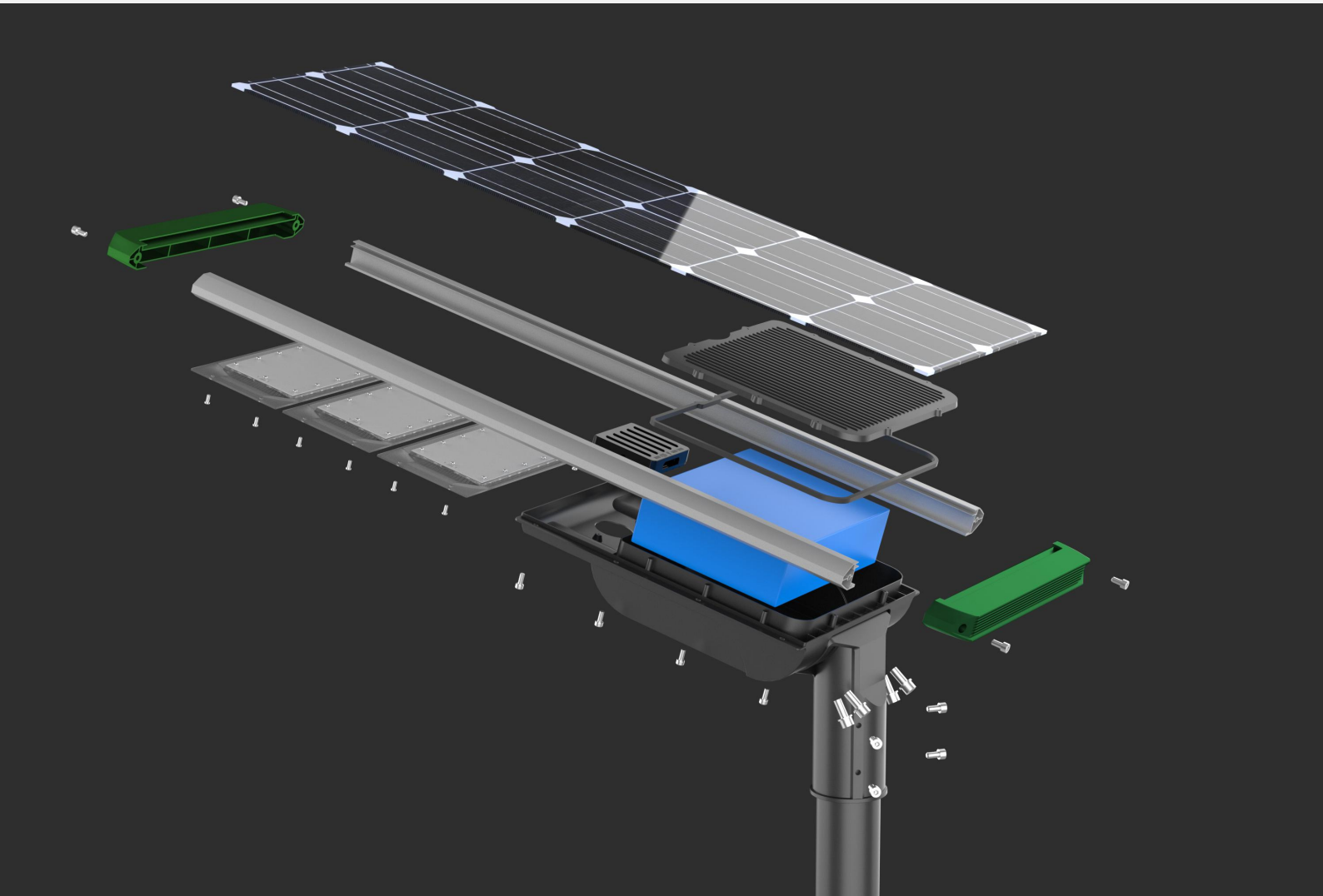

Equipado com controlo remoto com alcance até 30 metros, permite controlar várias luminárias.

Existem quatro modos de iluminação disponíveis de acordo com as preferências do utilizador.



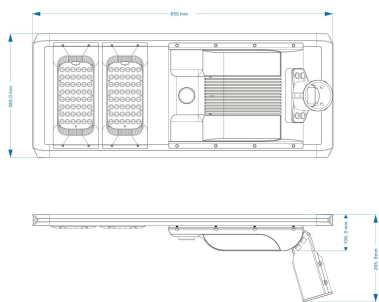

FX-40W

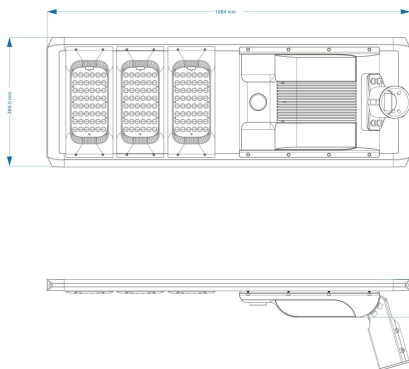

FX-50W/60W

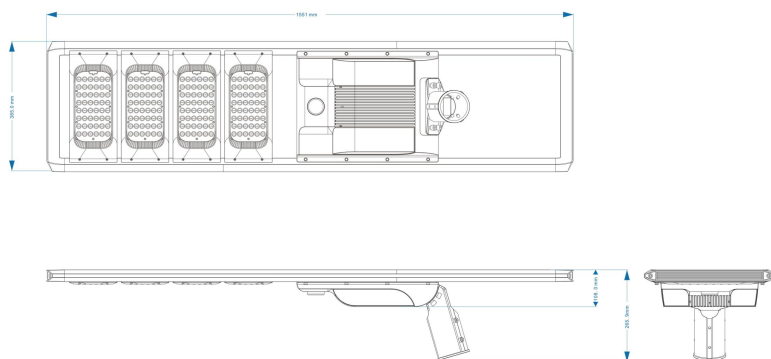

FX-80W

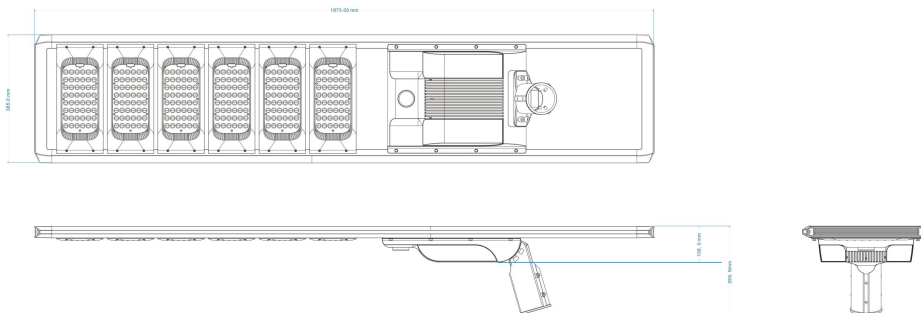

FX-100W/120W



Amplamente utilizado em estradas secundárias e rodovias, fábricas, parques, áreas montanhosas e remotas, pátios, escolas, praças e outros locais que requerem iluminação exterior sem ligação à rede.

