





MESA



EDCB011

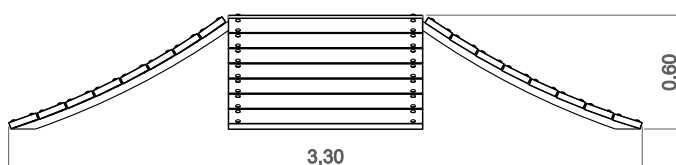
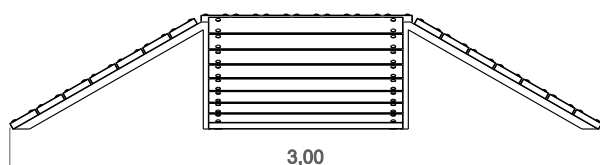

			
38m ²	0.60m	+8	1

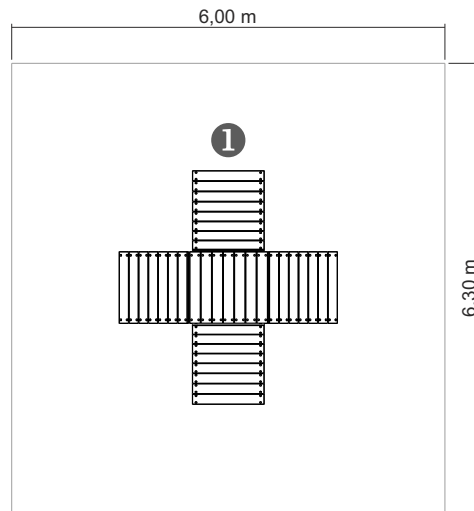



.....	①
	0,60
	38
	38

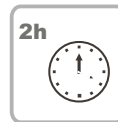
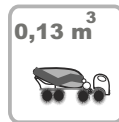

INFORMAÇÃO TÉCNICA / INFORMACIÓN TÉCNICA / TECHNICAL INFORMATION / INFORMATIONS TECHNIQUES

1 - Mesa  0.60m

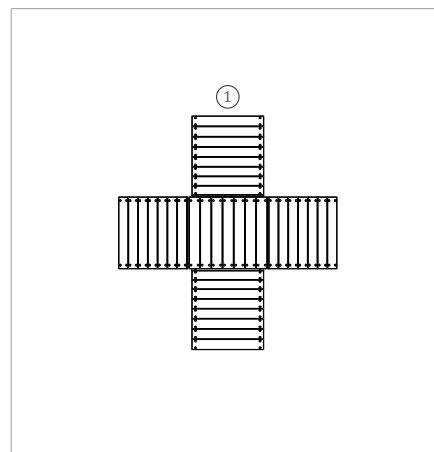



Superfície

Madeira: Pinho laminado classificado com qualidade de garantia por controlo interno contínuo. Com tratamento autoclave, protegendo-a dos ataques de cogumelos, insectos e térmitas. Acabamento final a tinta de base aquosa especialmente desenvolvida para proteger a madeira de humidades, intempéries e raios U.V.. Contém princípios activos que lhe conferem uma barreira protetora contra o aparecimento de fungos e bolores;

Peças Metálicas

Estrutura: Ferro com tratamento anticorrosivo de galvanização por imersão a quente de acordo com a norma EN ISO 1461;

Sistema de fixação

Tipo C – Sistema de fixação standard composto por prumo aplicado directamente no solo e chumbado com betão;

Parafusos e acessórios

Parafusos: Aço zincado ou opcionalmente aço inox AISI 304;

100%

PROTECTORES DECORATIVOS:

<p>Penetra profundamente na madeira destacando os veios e embelezando a madeira com as suas cores especiais transparentes</p>	<p>Muito resistente ao sol. Contém pigmentos micronizados absorventes e estabilizadores dos raios U.V.</p>	<p>Microporos, deixa respirar a madeira e evita as deformações naturais da madeira.</p>
<p>Fácil manutenção. Não é necessário lixar ou decapar para a aplicação de novas camadas.</p>	<p>PRINCÍPIOS ACTIVOS</p> <p>Conferindo ao filme uma barreira protectora contra fungos e bolores</p>	<p>HIDRÓFUGO</p> <p>protege contra a humidade, a chuva e impermeabiliza.</p>

C

SISTEMAS DE FIXAÇÃO / SISTEMAS DE FIJACIÓN
FIXING SYSTEMS / SYSTÈMES DE FIXATION



superficie

Madera: Pino laminado clasificado con calidad de garantía por control interno continuo. Con tratamiento autoclave, protegiéndola de los ataques de setas, insectos y termitas. Acabado final a tinta de base acuosa especialmente desarrollada para proteger la madera de humedad, intemperie y rayos U.V .. Contiene principios activos que le confieren una barrera protectora contra la aparición de hongos y mohos;

Piezas Metálicas

Estructura: Hierro con tratamiento anticorrosivo de galvanización por inmersión en caliente de acuerdo con la norma EN ISO 1461;

Sistema de fijación

Tipo C – Sistema de fijación estándar compuesto por pluma aplicada directamente en el suelo y plomado con hormigón;

Tornillos y accesorios

Tornillos: Acero zincado o opcionalmente acero inoxidable AISI 304;

100%

PROTECTORES DECORATIVOS:

 Penetra profundamente en la madera destacando los vetas y embellecer la madera con los sus colores especiales transparentes	 Muy resistente al sol, contiene pigmentos microoxidados absorbentes y estabilizadores de los rayos U.V.	 Microporoso, deja respirar la madera y evita las deformaciones naturales de la madera.
 Fác il mantenimiento. No es necesario lijar o decapar para la aplicación de nuevas capas.	<p>PRINCIPIOS ACTIVOS</p> que le da a la película una barrera protectora contra los hongos y los mohos	<p>HIDRÓFUGO</p> protege contra la humedad, la lluvia e impermeabiliza.

C

SISTEMAS DE FIXAÇÃO / SISTEMAS DE FIJACIÓN
FIXING SYSTEMS / SYSTÈMES DE FIXATION



Surface

Wood: Laminated pine classified with guarantee quality by continuous internal control. With autoclave treatment, protecting it from attacks of mushrooms, insects and termites. Water-based paint finish specially developed to protect wood from moisture, weather and U.V. rays. Contains active principles that give it a protective barrier against the appearance of fungi and molds;

Metal parts

Structure: Iron with hot dip galvanizing anticorrosion treatment according to EN ISO 1461;

Fixation System

Type C – Standard fixing system composed of plumbing applied directly to the ground and cast with concrete;

Screws and accessories

Screws: Zinc-plated steel or optionally AISI 304 stainless steel;

100%

DECORATIVE PROTECTORS:

 Penetrator deep into wood highlighting and embellishing the wood with their special transparent colors.	 Very resistant to sun. Contains absorbent micronized pigments and UV stabilizers.	 Microporous, let the wood breathe and prevents the natural deformations of the wood.
 Easy maintenance. No sanding or pickling is required for the application of new layers.	<p>ACTIVE PRINCIPLES</p> Giving the film a protective barrier against fungi and molds.	<p>WATER-REPELLENT</p> protects against moisture, rain and waterproof.

SISTEMAS DE FIXAÇÃO / SISTEMAS DE FIJACIÓN
FIXING SYSTEMS / SYSTÈMES DE FIXATION



Surface

Bois: Pin stratifié classé avec une qualité garantie par contrôle interne continu. Avec traitement autoclave, le protégeant des attaques de champignons, d'insectes et de termites. Finition de peinture à base d'eau spécialement développée pour protéger le bois contre l'humidité, les intempéries et les rayons UV. Contient des principes actifs qui lui confèrent une barrière protectrice contre l'apparition de champignons et de moisissures;

Pièces métalliques

Structure: Fer à repasser avec traitement anticorrosion par galvanisation à chaud selon la norme EN ISO 1461;

Système de fixation

Type C – Système de fixation standard composé de plomberie appliquée directement sur le sol et coulée avec du béton;

Vis et accessoires

Vis: Acier zingué ou acier inoxydable AISI 304 en option;



PROTECTEURS DÉCORATIFS:

<p>Pénètre profondément dans le bois en soulignant les veines et en embellissant le bois avec ses couleurs transparentes spéciales</p>	<p>Très résistant au soleil il contient des pigments microscopés d'absorption des stabilisants U.V.</p> <p>PRINCIPES ACTIFS</p> <p>Donnant au film une barrière protectrice contre les champignons et les moisissures</p>	<p>Microporeux, laisse respirer le bois et empêche les déformations naturelles du bois.</p> <p>HYDROFUGE</p> <p>protège contre l'humidité, la pluie et imperméable.</p>
--	--	--

