

Tolerância Geral: ± 5%



54,00 m<sup>2</sup>



1,30 m



3-14



11



Parques Infantis  
Playground

Parques Infantiles  
Aires de Jeux

ESPAÑA  
[www.bricantel.com](http://www.bricantel.com)  
[info@bricantel.com](mailto:info@bricantel.com)

PORTUGAL  
[www.bricantel.pt](http://www.bricantel.pt)  
[info@bricantel.pt](mailto:info@bricantel.pt)

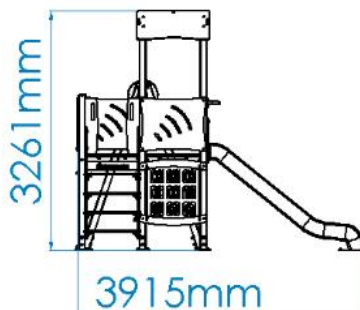
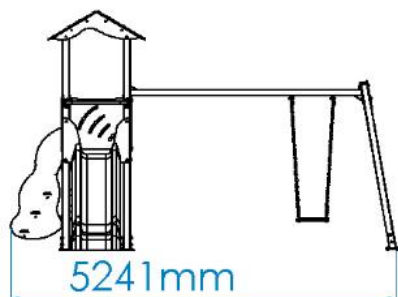
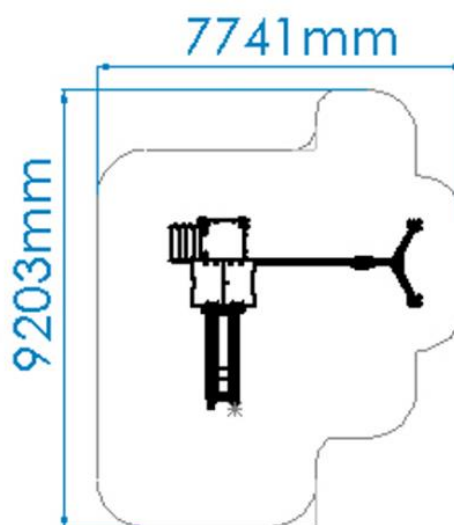
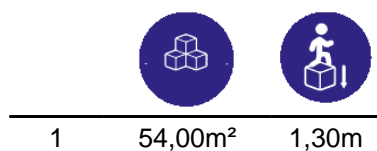

 @bricantel  
 bricantelpt  
 @bricantel

**MEDIDAS GERAIS / MEDIDAS GENERALES / GENERAL MEASURES / MESURES GÉNÉRALES**

**INSTALAÇÃO / INSTALACIÓN / INSTALLATION / INSTALLATION**

0,95m<sup>3</sup>



05:00h



3x



24,00kg



534,00kg





## DESCRIÇÃO

Equipamento BragPLAY, Danaus Park IRIS (AQL - 1.30m), composto por:

- 1 torre Nuvem com telhado de duas águas em Bragpo (AQL - 1,30m), prumos alumínio 90x90mm e plataformas com estrutura galvanizada revestida a Bragpo;
- 1 torre Simples sem telhado (AQL - 1,30m), prumos alumínio 90x90mm e plataformas com estrutura galvanizada revestida a Bragpo;

Vias de acesso:

- 1 escorrega Savana (AQL - 1,30m) em Bragpo rotomoldado com painel de resguardo em Bragpo;
- 1 escada Folha (AQL - 1,30m) com laterais em Bragpo e quatro degraus em contraplacado marítimo antiderrapante castanho;
- 1 baloiço Zea com pórtico simples, 1 varão horizontal Ø80mm em aço galvanizado, sistema de rotação em aço inox com rolamentos, 2 prumos em madeira 90x90mm cor cerejeira, 1 painel decorativo em Bragpo, 1 assento plano em borracha termoplástica com correntes galvanizadas Ø5mm.

Complementos:

- 1 par de pegas em Bragpo;
- 1 guarda corpos curvo em tubo Ø40mm em aço inox;
- 4 painéis barreira Wifi de proteção com quatro rasgos em Bragpo;
- Painel Lúdico Jogo do Galo com 9 peças quadradas rotativas (X&O) e painéis decorativos em Bragpo.

Ferragens em aço inox.

Fixação ao solo tipo X (aparafusar).

Medidas gerais (CxLxA): 5241x3915x3261mm

Área de segurança: 54m<sup>2</sup> | Área livre: 7741x9203mm

Faixa etária: 3-14 anos

Nº de utilizadores: 11

## CARACTERÍSTICAS TÉCNICAS



### PRUMO QUADRADO ALUMÍNIO

Prumo de perfil quadrado de 90x90x3mm em alumínio, Liga EN AW-6063 (Al Mg0.7Si) com tratamento de calor T66, devido à sua versatilidade, é uma das ligas mais usadas, principalmente em aplicações onde se pretendem propriedades mecânicas moderadas, em simultâneo com uma boa resposta à anodização. Apresenta uma boa resistência à corrosão e boas características de soldabilidade, de acordo com as normas EN 12020 e EN 755; Tacos em BragPO aparafusados ao perfil.

Garantia: 15 anos

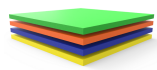

### BRAGPO

BragPO HDPE de alta densidade monocolor ou bicolor, livre de HPA. Caracterizado pela sua extrema leveza e elasticidade, resistência a produtos químicos, corrosão, raios UV (UNE EN ISO 4892), alta resistência à inflamabilidade (UNE-EN ISO 11925-2) e resistência a impactos (ISO 527-1). Não necessita de qualquer manutenção.

Garantia: 15 anos

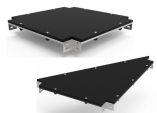

### PLATAFORMAS EM BRAGPO

Plataformas quadradas e triangulares com estrutura metálica galvanizada que combina a característica da resistência mecânica do aço com a resistência à corrosão pelo zinco.

Reforçada com painel BragPO de alta densidade monocolor ou bicolor, livre de HPA. Caracterizado pela sua extrema leveza e elasticidade, resistência a produtos químicos, corrosão, raios UV (UNE EN ISO 4892), alta resistência à inflamabilidade (UNE-EN ISO 11925-2) e resistência a impactos (ISO 527-1). Não necessita de qualquer manutenção. Reforçada com uma estrutura metálica galvanizada, conferindo uma elevada resistência mecânica bem como resistência aos elementos corrosivos.

Garantia: 15 anos



### ESCORREGA BRAGPO

BragPO roto moldado, com grande resistência a produtos químicos, corrosão, raios UV (UNE EN ISO 4892), alta resistência à inflamabilidade (UNE-EN ISO 11925-2) e resistência a impactos (ISO 527-1). Não necessita de qualquer manutenção.



### ASSENTO PLANO

Em borracha termoplástica, com reforço interior em alumínio. Correntes com Ø5mm em aço galvanizado a quente.



### ROLAMENTO ESFÉRICO

Rolamentos esféricos rígidos de uma carreira de esferas tampados com vedação em borracha para o fechamento, de acordo com a norma DIN 925-1.



### FERRAGENS EM AÇO INOX

Ferragens em aço inox, de acordo com a norma NF EN 10088, protegidas por cápsulas em polipropileno PP.

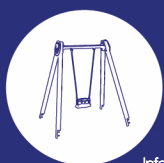

Parques Infantis  
Playground

Parques Infantiles  
Aires de Jeux

Informação sujeita a alterações sem aviso prévio.

ESPAÑA  
www.bricantel.com  
info@bricantel.com

PORTUGAL  
www.bricantel.pt  
info@bricantel.pt



@bricantel  
bricantelpt  
@bricantel

Data de exportação: 01/02/2024

**VARÃO HORIZONTAL GALVANIZADO**

Em tubo de perfil circular (EN 10305-3), laminado a quente (EN 10027-1 e CR 10260), em aço galvanizado DX51D+Z275, de acordo com a norma EN 10346.

Garantia: 15 anos

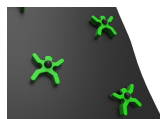
**PEDRAS ESCALADA (DUMMY)**

Fabricados em polietileno de alta densidade monocolor ou bicolor, livre de HPA. É um polímero de extrema leveza e elasticidade caracterizado pela resistência a produtos químicos, corrosão, raios UV (UNE EN ISO 4892), alta resistência à inflamabilidade (UNE-EN ISO 11925-2) e resistência a impactos (ISO 527-1). Impossibilita o cultivo tanto de bactérias como de fungos. Não necessita de qualquer manutenção.

**GUARDA CORPOS**

Fabricados em tubo Ø40mm em aço inoxidável AISI 304, de acordo com a norma EN 14301, com acabamento 2B.

Garantia: 15 anos.

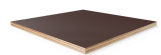
**CONTRAPLACADO MARÍTIMO**

Laminado colado com resinas fenólicas a alta pressão e temperatura, resistente a intempéries e raios UV, de acordo com as normas EL 314-2/classe 3 (DIN 68 TS TCIL3: BFU 100, BS 6566 PART 8: WBP); antiderrapante e de baixa manutenção.

Garantia: 5 anos

**ESCADA FOLHA**

Escadas constituídas com laterais em brago: polietileno de alta densidade monocolor ou bicolor. Por ser um polímero é caracterizado pela sua resistência a produtos químicos e à corrosão. Pela sua capacidade de elasticidade e leveza, oferece alta resistência ao impacto, sendo muito difícil quebrar. A superfície antiderrapante fornece segurança para as crianças e a sua base sintética impede o cultivo de bactérias e fungos. Não necessita de qualquer manutenção e quatro degraus em contraplacado marítimo antiderrapante castanho e colado com resinas fenólicas resistentes as intempéries e raios UV. em conformidade com as normas EL 314-2/classe 3 (DIN 68 TS TCIL3: BFU 100, BS 6566 PART 8 : WBP).

**SISTEMA DE FIXAÇÃO**

Tipo X - Sistema de fixação composto por base metálica aparafusada ao solo rígido.

A base metálica é fabricada em chapa de aço carbono, com tratamento anticorrosivo de galvanização por imersão a quente com espessura entre 120 a 140µm de acordo com a norma EN ISO 1461, que permite a sua colocação sem que o prumo entre em contacto direto com o solo. A sua fixação ao prumo é feita por um sistema de aperto rápido aumentando a longevidade do prumo e a sua fácil e rápida substituição em caso de necessidade.



## FUNÇÕES LÚDICAS



### DIVERSÃO

Enquanto se divertem, as crianças desenvolvem imensas capacidades, tais como: habilidades físicas, emocionais, sociais e motoras.



### SOCIALIZAR

A importância de brincar reside no facto das brincadeiras promoverem a interação social, despertando-lhes o senso de convivência e solidariedade. Enquanto brincam, as crianças aprendem a partilhar, respeitar e ouvir os outros, desta forma iniciam a sua preparação para viver em sociedade.



### BALOIÇAR

Esta ação ajuda a desenvolver o equilíbrio da criança e ensina-lhe como controlar os movimentos com o balanço e vigor correto, o que melhora a atividade psicomotora e coordenação do corpo. O ato de baloiçar é essencialmente importante para crianças com défice ao nível de perceção visual, uma vez que ajuda o cérebro a processar a velocidade e o sentido do movimento.



### ESCORREGAR

A superfície inclinada permite que a criança deslize a grande velocidade, aumentando a sua adrenalina. Esta sensação desperta novas emoções, permitindo controlar os movimentos, exercitando os reflexos e as habilidades motoras. Este movimento ajuda a criança a controlar o seu comportamento em situações de desconforto emocional e/ou físico.



### CONSTRUIR

Alguns jogos e brincadeiras, são desenvolvidos para que as crianças se deparem com desafios que as obriguem a pensar e construir uma solução benéfica que as ajude a encarar a problemática quer a nível emocional quer a nível social.



### ESTIMULAÇÃO VISUAL

É através da estimulação visual, que as crianças adquirem estímulos essenciais que vão impulsionar o desenvolvimento do seu campo visual. Assim, é essencial que estas desenvolvam uma visão funcional, que as permita brincar, socializar para interiorizar informações do meio que as rodeia e desenvolver competências.



### ESTIMULAÇÃO TÁTIL

É através do ato de brincar que se consegue estimular o sistema tátil de uma forma fácil e simples, a introdução de objetos com diferentes texturas permite que as crianças comecem a utilizar as mãos e desta forma, despertar a sua perceção sensorial tátil.



### CRIATIVIDADE

São ações como inventar, sonhar, pensar e experimentar, que desenvolvem a criatividade das crianças. Dessa forma, estas passam a compreender e a usar as suas competências orais, motoras e cognitivas nas mais diversas atividades.



### DESENVOLVIMENTO COGNITIVO

Um aspeto importante do ato de brincar, é o desenvolvimento do raciocínio, da sua imaginação e atenção. Novas brincadeiras são essenciais para estimular a capacidade de pensar, compreender e agir, desenvolvendo o sistema cognitivo.



**NORMAS**

EN 1176-1  
Equipamentos e superfícies para espaços de jogo e recreio  
Parte 1: Requisitos de segurança e métodos de ensaio gerais



EN 1176-2  
Equipamentos e superfícies para espaços de jogo e recreio  
Parte 2: Requisitos de segurança e métodos de ensaio adicionais, específicos para baloiços



EN 1176-3  
Equipamentos e superfícies para espaços de jogo e recreio  
Parte 3: Requisitos de segurança específicos adicionais e métodos de ensaio para escorregas

**CONFIDENCIALIDADE E PROPRIEDADE INTELECTUAL**

A informação contida neste documento é confidencial, não podendo o destinatário do mesmo reproduzi-la ou permitir a terceiros que a obtenham, utilizem ou divulguem sem a prévia e expressa autorização da BRICANTEL.

Todos os direitos de propriedade intelectual sobre os desenhos e modelos apresentados são da titularidade exclusiva da BRICANTEL, sendo expressamente proibida a prática de qualquer ato de exploração dos mesmos sem o consentimento desta, nos termos do código da propriedade industrial e do código do direito de autor e dos direitos conexos. A violação da obrigação de confidencialidade e/ou dos direitos de propriedade intelectual da BRICANTEL, pode dar origem a responsabilidade civil e criminal.

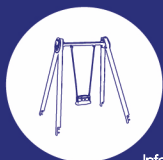

Parques Infantis  
Playground

Parques Infantiles  
Aires de Jeux

Informação sujeita a alterações sem aviso prévio.

ESPAÑA  
[www.bricantel.com](http://www.bricantel.com)  
[info@bricantel.com](mailto:info@bricantel.com)

PORTUGAL  
[www.bricantel.pt](http://www.bricantel.pt)  
[info@bricantel.pt](mailto:info@bricantel.pt)



 @bricantel  
 bricantelpt  
 @bricantel

Data de exportação: 01/02/2024



## DESCRIPCIÓN

Equipamiento BragPLAY Danaus Park "IRIS" (HIC - 1.30m), compuesto por:

- 1 Torre "Nube" con tejado a dos aguas en Bragpo (HIC - 1,30m), postes de aluminio de 90x90mm y plataformas con estructura galvanizada revestida en Bragpo;

- 1 Torre Simple sin tejado (HIC - 1,30m), postes de aluminio de 90x90mm y plataformas con estructura galvanizada revestida en Bragpo;

Vías de acceso:

- 1 Tobogán "Sabana" (HIC - 1,30m) en Bragpo rotomoldeado con panel de protección en Bragpo;

- 1 Escalera "Hoja" (HIC - 1,30m) con laterales en Bragpo y cuatro peldaños en contrachapado marino antideslizante marrón;

- 1 Columpio "Zea" de pórtico simple, 1 barra horizontal de Ø80mm en acero galvanizado, sistema de rotación de acero Inox con rodamientos, 2 postes de madera de 90x90mm color cerezo, 1 panel decorativo en Bragpo, 1 asiento plano de goma termoplástica con cadenas galvanizadas de Ø5mm.

Complementos:

- 1 Par de Asideros en Bragpo;

- 1 Protector corporal curvo en tubo de Ø40mm en acero Inox;

- 4 Paneles "Wifi" de protección con cuatro grabados en Bragpo;

- Panel lúdico "Juego Tres en Raya" compuesto por 9 piezas cuadradas rotativas y paneles decorativos en Bragpo.

Herrajes de acero Inox.

Fijación al suelo Tipo X (atornillado).

Medidas generales (LxAnxA): 5241x3915x3261mm

Área de seguridad: 54m<sup>2</sup> | Área libre: 7741x9203mm

Rango de edad: 3-14 años

Nº de usuarios: 11 niños

## CARACTERÍSTICAS TÉCNICAS



### POSTE ALUMINIO

Poste de perfil cuadrado de 90x90x3mm en aluminio, aleación ENAW-6063 (AlMg0.7Si) con tratamiento térmico T66, por su versatilidad, es una de las aleaciones más utilizadas, principalmente en aplicaciones donde se desean propiedades mecánicas moderadas, simultáneamente cuenta también con una gran resistencia a la corrosión y buenas condiciones de durabilidad, de acuerdo con las normas EN12020 y EN755. Tapas en BragPO atornilladas al perfil.

Garantía: 15 años.

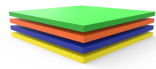

### BRAGPO

BragPO HDPE de alta densidad monocolor o bicolor, sin HPA. Caracterizado por su extrema ligereza y elasticidad, resistencia a productos químicos, corrosión, rayos UV (UNE EN ISO 4892), a la inflamabilidad (UNE-EN ISO 11925-2) y al impacto (ISO 527-1). No necesita ningún tipo de mantenimiento.

Garantía: 15 años

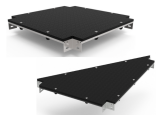

### PLATAFORMAS EN BRAGPO

Estructura metálica galvanizada que combina la resistencia mecánica del acero con la resistencia a la corrosión por zinc. Reforzado con panel BragPO de alta densidad monocolor o bicolor, sin HPA. Caracterizado por su extrema ligereza y elasticidad, resistencia a productos químicos, corrosión, rayos UV (UNE EN ISO 4892), a la inflamabilidad (UNE-EN ISO 11925-2) y al impacto (ISO 527-1). No necesita ningún tipo de mantenimiento.

Reforzado con una estructura metálica galvanizada, proporcionando una alta resistencia mecánica, así como resistencia a los elementos corrosivos.

Garantía: 15 años.



### TOBOGÁN BRAGPO

BragPO rotomoldeado, con gran resistencia a productos químicos, corrosión, rayos UV (UNE EN ISO 4892), alta resistencia a la inflamabilidad (UNE-EN ISO 11925-2) y resistencia a los impactos (ISO 527-1). No necesita ningún tipo de mantenimiento.



### ASIENTO PLANO

En caucho termoplástico, con refuerzo interior de aluminio. Cadenas de Ø5mm en acero galvanizado en caliente.



### RODAMIENTO ESFÉRICO

Rodamientos esféricos rígidos de una hilera con junta de goma de cierre, según DIN 925-1.



### HERRAJES EN ACERO INOX

Herrajes en acero inox, según NF EN 10088, protegidos por cápsulas en polipropileno PP.



Parques Infantis  
Playground

Parques Infantiles  
Aires de Jeux

Informação sujeita a alterações sem aviso prévio.

ESPAÑA  
www.bricantel.com  
info@bricantel.com

PORTUGAL  
www.bricantel.pt  
info@bricantel.pt



@bricantel  
bricantelpt  
@bricantel

Data de exportação: 01/02/2024

**BARRA HORIZONTAL GALVANIZADA**

En tubo de perfil circular (EN 10305-3), laminado en caliente (EN 10027-1 y CR 10260), de acero galvanizado DX51D +Z275, según la norma EN 10346.  
Garantía: 15 años

**ROCÓDROMO ESCALADA (DUMMY)**

Fabricados en polietileno de alta densidad monocolor o bicolor, sin HPA. Es un polímero de extrema ligereza y elasticidad caracterizado por resistencia a productos químicos, corrosión, rayos UV (UNE EN ISO 4892), alta resistencia a la inflamabilidad (UNE-EN ISO 11925-2) y resistencia al impacto (ISO 527-1). Imposibilita el cultivo tanto de bacterias como de hongos. No necesita ningún tipo de mantenimiento.

**PROTECTORES CORPORALES**

Fabricado en tubo de acero inoxidable AISI 304 Ø40mm, de acuerdo con la norma EN 14301, con acabado 2B.  
Garantía: 15 años.

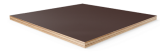
**MADERA CONTRACHAPADA MARINA**

Laminado pegado con resinas fenólicas a alta presión y temperatura, resistente a la intemperie y a los rayos UV, de acuerdo con las normas EL 314-2/clase 3 (DIN 68 TS TCIL3: BFU 100, BS 6566 PART 8: WBP); antideslizante y de bajo mantenimiento.  
Garantía: 5 años

**ESCALERA HOJA**

Escaleras constituidas con laterales en braggo: polietileno de alta densidad monocolor o bicolor. Por ser un polímero se caracteriza por su resistencia a los productos químicos y a la corrosión. Por su capacidad de elasticidad y ligereza, ofrece alta resistencia al impacto, siendo muy difícil su ruptura. La superficie antideslizante proporciona seguridad a los niños y su base sintética impide el cultivo de bacterias y hongos. No requiere ningún mantenimiento y cuatro peldaños en contrachapado marino antideslizante marrón y pegado con resinas fenólicas resistentes a la intemperie y los rayos UV. de conformidad con las normas EL 314-2/clase 3 (DIN 68 TS TCIL3: BFU 100, BS 6566 PART 8 : WBP).

**SISTEMA DE FIJACIÓN**

Tipo X - Sistema de fijación compuesto por una base metálica y atornillada al suelo rígido.

La base metálica es fabricada en chapa de acero al carbono, con tratamiento anticorrosivo de galvanización por inmersión en caliente con espesor entre 120 y 140µm de acuerdo con la norma EN ISO 1461, que permite su colocación sin que la viga entre en contacto directo con el suelo. Su fijación a la viga es hecha por un sistema de sujeción rápido aumentando la longevidad de la viga y su fácil y rápida sustitución en caso de necesidad.

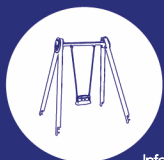



**FUNCIONES DE JUEGO****DIVERSIÓN**

Mientras se divierten, los niños desarrollan una gran diversidad de capacidades, tales como: habilidades físicas, emocionales, sociales y motrices.

**SOCIALIZAR**

La importancia del juego reside en que éste, promueve la interacción social, despertando en los niños la necesidad de convivencia y solidaridad. Mientras juegan, los niños aprenden a compartir, respetar y escuchar a los demás niños. Es la mejor forma de iniciar su preparación para convivir en sociedad.

**COLUMPIARSE**

Esta acción le ayuda a desarrollar el equilibrio, enseñándole cómo controlar los movimientos a través del balanceo, así como a utilizar la energía necesaria correcta, lo que mejora la actividad psicomotora y coordinación del propio cuerpo. El efecto del balanceo es esencialmente importante para niños con cierto déficit a nivel de percepción visual, ya que ayuda a su cerebro a procesar la velocidad y el concepto del movimiento.

**DESLIZARSE**

Una superficie inclinada permite que el niño se deslice a cierta velocidad, aumentando, de esta manera, la liberación de su adrenalina. Esta sensación despierta nuevas emociones, permitiendo controlar los movimientos, ejercitando los reflejos y las habilidades motoras. Este movimiento permite a los niños controlar su comportamiento en ciertas situaciones de incomodidad emocional y/o física.

**CONSTRUIR**

Algunos juegos están especialmente desarrollados para que los niños afronten retos que les obliguen a pensar y a construir una solución productiva que les ayude a enfrentar cualquier tipo de problema, ya sea a nivel emocional o a nivel social.

**ESTIMULACIÓN VISUAL**

A través de la estimulación visual, los niños adquieren incentivos esenciales que van a aumentar el desarrollo de su campo visual. De esta manera, es primordial que ellos desarrollen una visión funcional que les permita jugar y socializar para interiorizar informaciones del medio que los rodea, así como a desarrollar capacidades.

**ESTIMULACIÓN TÁCTIL**

A través del acto del juego se consigue estimular el sentido táctil de una forma fácil y simple. La introducción de objetos con diferentes texturas permite que los niños comiencen a utilizar las manos, y de esta forma, se despierte su percepción sensorial táctil.

**CREATIVIDAD**

Se trata de acciones tales como inventar, soñar, pensar y percibir, que desarrollan la creatividad de los niños. De esta manera pasan a comprender y a usar sus competencias orales, motoras y cognitivas en las más diversas actividades.

**DESARROLLO COGNITIVO**

Un aspecto importante del simple acto de jugar es el desarrollo del raciocinio, de su imaginación y atención. Son esenciales nuevas diversiones, a través del juego, para estimular la capacidad de pensar, comprender y reaccionar, desarrollando así, el sistema cognitivo.

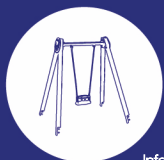

**NORMAS**

EN 1176-1  
Equipamiento de las áreas de juego y superficies  
Parte 1: Requisitos generales de seguridad y métodos de ensayo.



EN 1176-2  
Equipamiento de las áreas de juego y superficies  
Parte 2: Requisitos de seguridad y métodos de ensayo adicionales específicos para columpios



EN 1176-3  
Equipamiento de las áreas de juego y superficies  
Parte 3: Requisitos de seguridad y métodos de ensayo adicionales específicos para toboganes

**CONFIDENCIALIDAD Y PROPIEDAD INTELECTUAL**

La información contenida en este documento es estrictamente confidencial, no pudiendo el destinatario reproducirla o permitir a terceros que la adquieran, utilicen o divulguen sin la previa y expresa autorización de BRICANTEL.

Todos los derechos de propiedad intelectual sobre los diseños y modelos presentados son de titularidad exclusiva de BRICANTEL, estando expresamente prohibida la práctica de cualquier acto de usurpación de los mismos sin el previo consentimiento de la empresa, dentro de los términos del código de propiedad industrial y del código de derechos de autor y derechos análogos. La violación de la obligación de confidencialidad y/o de los derechos de propiedad intelectual de BRICANTEL, puede dar origen a responsabilidad civil y criminal.



Parques Infantis  
Playground

Parques Infantiles  
Aires de Jeux

Informação sujeita a alterações sem aviso prévio.

ESPAÑA  
[www.bricantel.com](http://www.bricantel.com)  
[info@bricantel.com](mailto:info@bricantel.com)

PORTUGAL  
[www.bricantel.pt](http://www.bricantel.pt)  
[info@bricantel.pt](mailto:info@bricantel.pt)



@bricantel  
bricantelpt  
@bricantel

Data de exportação: 01/02/2024



## DESCRIPTION

BragPLAY equipment, Danaus Park IRIS (FFH - 1.30m), comprising:

- 1 Cloud tower with gable roof in Bragpo (FFH - 1.30m), 90x90mm aluminum props and platforms with galvanized structure coated in Bragpo;

- 1 simple tower without roof (FFH - 1.30m), 90x90mm aluminum props and platforms with galvanized structure coated with Bragpo;

Access routes:

- 1 Savannah slide (FFH - 1.30m) in rotomolded Bragpo with Bragpo guard panel;

- 1 Leaf ladder (FFH - 1.30m) with Bragpo sides and four steps in brown non-slip marine plywood;

- 1 Zea swing with single gantry, one Ø80mm horizontal galvanized steel pole, one stainless steel rotation system with bearings, two 90x90mm cherry wood props, one decorative Bragpo panel, one flat thermoplastic rubber seat with Ø5mm galvanized chains.

Accessories:

- 1 pair of Bragpo handles;

- 1 curved guardrail in Ø40mm stainless steel tube;

- 4 protective Wifi barrier panels with four slots in Bragpo;

- Tic-tac-toe play panel with 9 rotating square pieces (X&O) and decorative panels in Bragpo.

Stainless steel fittings.

X-type ground fixing (screw).

Dimensions (LxWxH): 5241x3915x3261mm

Safety area: 54m<sup>2</sup> | Free area: 7741x9203mm

Age range: 3-14 years

Number of users: 11

## TECHNICAL FEATURES



### ALUMINUM BEAM

Square profile beam of 90x90x3mm in aluminum, ENAW-6063 Alloy (AlMg0.7Si) with T66 heat treatment, due to its versatility, it's one of the most used alloys, mainly in applications where moderate mechanical properties are released, simultaneously with a good resistance corrosion and good solvency characteristics, according to EN12020 and EN755; BragPO cover fixed to the profile.

Guarantee: 15 years.

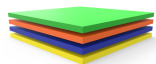

### BRAGPO

BragPO HDPE of high density in one color or bicolor, free of HPA. Characterized by its extreme lightness and elasticity, resistance to chemicals, corrosion, UV rays (UNE EN ISO 4892), to flammability (UNE-EN ISO 11925-2) and impact (ISO 527-1). It doesn't need any maintenance.

Guarantee: 15 years.

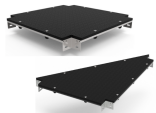

### PLATFORM IN BRAGPO

A galvanized metallic structure that combines the characteristic of the mechanical resistance of the steel with the resistance to corrosion by zinc.

Reinforced with BragPO of high density with one color or bicolor, free of HPA. Characterized by its extreme lightness and elasticity, resistance to chemicals, corrosion, UV rays (UNE EN ISO 4892), to flammability (UNE-EN ISO 11925-2) and impact (ISO 527-1). It doesn't need any maintenance. Reinforced with a galvanized metallic structure, providing a high mechanical resistance as well as resistance to corrosive elements.

Guarantee: 15 years



### BRAGPO SLIDE

Broken molded BragPO, with great resistance to chemicals, corrosion, UV rays (UNE EN ISO 4892), high resistance to flammability (UNE-EN ISO 11925-2) and impact resistance (ISO 527-1). Maintenance free.



### SIMPLE HANGING SWING

In thermoplastic rubber, with aluminum inner reinforcement. Chains with Ø5mm in hot-dip galvanized steel.



### SPHERICAL BEARING

Single row rigid spherical ball bearings with rubber seal for closing, in accordance with DIN 925-1.



### STAINLESS STEEL HARDWARE

Stainless steel, in accordance with NF EN 10088, protected by polypropylene PP capsules.



Parques Infantis  
Playground

Parques Infantiles  
Aires de Jeux

ESPAÑA  
www.bricantel.com  
info@bricantel.com

PORTUGAL  
www.bricantel.pt  
info@bricantel.pt



@bricantel  
bricantelpt  
@bricantel

**GALVANISED HORIZONTAL BAR**

In circular profile tube (EN 10305-3), hot rolled (EN 10027-1 and CR 10260), in galvanised steel DX51D+Z275 according to EN 10346.

Guarantee: 15 years

**ROCK CLIMBING (DUMMY)**

Made of high density in one color or bicolor polyethylene, free of HPA. It is a polymer of extreme lightness and elasticity characterized by resistance to chemicals, corrosion, UV rays (UNE EN ISO 4892), high flammability resistance (UNE-EN ISO 11925-2) and impact resistance (ISO 527-1). It makes it impossible to grow both bacteria and fungi.

**BODYGUARD**

Made of stainless steel AISI 304 tube Ø40mm, according to EN 14301, with 2B finish.

Guarantee: 15 years.

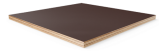
**MARINE PLYWOOD**

Laminated glued with phenolic resins at high pressure and temperature, weather and UV resistant, according to EL 314-2/class 3 standards (DIN 68 TS TCIL3: BFU 100, BS 6566 PART 8: WBP); non-slip and low maintenance.

Warranty: 5 years old

**STAIRCASE FOLHA**

Staircases with sides in bragpo: polyethylene of high density monocolour or bicolor. Being a polymer is characterized by its resistance to chemicals and corrosion. Due to its elasticity and lightness, it offers high resistance to impact, being very difficult to break. The non-slip surface provides safety for children and its synthetic base prevents the cultivation of bacteria and fungus. It does not require any maintenance and four steps in marine plywood anti-slip brown and glued with phenolic resins resistant to weathering and UV rays. in accordance with EL 314-2/Class 3 (DIN 68 TS TCIL3: BFU 100, BS 6566 PART 8 : WBP).

**FIXATION SYSTEM**

Type X - Fixation system composed of a metal base bolted to the hard ground.

The metal base is made of carbon steel sheet, with corrosion-resistant hot-dip galvanisation treatment of between 120 and 140µm thickness according to EN ISO 1461, which allows its placement without the plumb in direct contact with the ground. Its attachment to the plumb line is made by a quick clamping system increasing the longevity of the plumb line and its easy and fast replacement in case of need.

**PLAY FUNCTIONS****FUN**

While having fun, children acquire immense abilities, from physical abilities to social interactions.

**SOCIALIZING**

Socialization and imagination are necessary throughout the game. All this creates a relationship between children and awakens the sense of coexistence and solidarity.

**SWING**

This action helps to develop the child's balance and teaches him how to control the movements with the correct balance and vigor, which improves the psychomotor activity and body coordination. Swinging is essentially important for children with a visual perception deficit, as it helps the brain process the speed and direction of movement.

**SLIDE**

The inclined surface allows the child to slide at great speed, increasing his adrenaline. This sensation awakens new emotions, allowing to control movements exercising reflexes and motor skills. This movement helps the child to control their behavior in situations of emotional and/or physical discomfort.

**BUILD**

Some games are developed so that children face challenges that force them to think and build a beneficial solution that helps them face the problem, emotionally or socially.

**VISUAL STIMULATION**

It's through visual stimulation that children acquire essential stimuli that will boost the development of their visual field. Thus, it's essential that they develop a functional vision that allows them to play, socialize to internalize information from their surroundings and develop skills.

**TACTILE STIMULATION**

It's through the act of play that it's possible to stimulate the tactile system in an easy and simple way, the introduction of objects with different textures allows children to start using their hands and thus awaken their tactile sensory perception.

**CREATIVITY**

These are actions such as inventing, dreaming, thinking and experimenting, which develop children's creativity. In this way, they begin to understand and use their oral, motor and cognitive skills in the most diverse activities.

**COGNITIVE DEVELOPMENT**

An important aspect of play is the development of reasoning, imagination and attention. New games are essential to stimulate the ability to think, understand and act, developing the cognitive system.

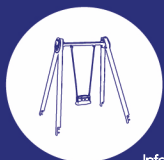

**STANDARTS**

EN 1176-1  
Playground equipment and surfacing  
Part 1: General safety requirements and test methods



EN 1176-2  
Playground equipment and surfacing  
Part 2: Additional specific safety requirements and test methods for swings



EN 1176-3  
Playground equipment and surfacing  
Part 3: Additional specific safety requirements and test methods for slides

**CONFIDENTIALITY AND INTELLECTUAL PROPERTY**

The information contained in this document is confidential, and the recipient cannot reproduce it or allow third parties to obtain, use or disclose it without the prior and express authorization of BRICANTEL. All intellectual property rights over the designs and models presented are the exclusive property of BRICANTEL, and the practice of any act of exploitation thereof without the consent of the latter, under the terms of the industrial property code and the copyright code and related rights. Violation of BRICANTEL's obligation of confidentiality and / or intellectual property rights may give rise to civil and criminal liability.



Parques Infantis  
Playground

Parques Infantiles  
Aires de Jeux

Informação sujeita a alterações sem aviso prévio.

ESPAÑA  
[www.bricantel.com](http://www.bricantel.com)  
[info@bricantel.com](mailto:info@bricantel.com)

PORTUGAL  
[www.bricantel.pt](http://www.bricantel.pt)  
[info@bricantel.pt](mailto:info@bricantel.pt)



 @bricantel  
 bricantelpt  
 @bricantel

Data de exportação: 01/02/2024



## DESCRIPTION

Équipement BragPLAY, Danaus Park IRIS (HCL - 1,30m), comprenant:

- 1 tourelle Nuage avec toit à pignon en Bragpo (HCL - 1,30m), des poteaux en aluminium de 90x90mm et plateformes avec structure galvanisée revêtue de Bragpo;
- 1 tourelle simple sans toit (HCL - 1,30m), des poteaux en aluminium de 90x90mm et plateformes avec structure galvanisée revêtue de Bragpo;

Voies d'accès:

- 1 toboggan Savane (HCL - 1,30m) en Bragpo rotomoulé avec panneau de protection en Bragpo;
- 1 échelle Feuille (HCL - 1,30m) avec rampes latérales en Bragpo et quatre échelons en contreplaqué marine marron antidérapant;
- 1 balançoire Zea avec portique simple, 1 poutre horizontale de Ø80mm en acier galvanisé, un système de rotation en acier inoxydable avec roulements, 2 poteaux en bois de 90x90mm couleur bois de cerisier, 1 panneau décoratif en Bragpo, 1 siège plat en caoutchouc thermoplastique avec chaînes galvanisées de Ø5mm.

Accessoires:

- 1 paire de poignées en Bragpo;
- 1 garde-corps courbe en tube inox de Ø40mm;
- 4 panneaux de protection Wifi avec 4 fentes en Bragpo;
- Panneau ludique morpion avec 9 pièces carrées rotatives (X & O) et panneaux décoratifs en Bragpo.

Visserie en acier inoxydable.

Fixation au sol de type X (visser).

Dimensions (Lxlxh): 5241x3915x3261mm

Zone de sécurité: 54m2 | Zone libre: 7741x9203mm

Tranche d'âge: 3-14 ans

Nombre d'utilisateurs: 11

## CARACTÉRISTIQUES TECHNIQUES



### POUTRE ALUMINIUM

Poutre à profil carré 90x90x3mm en aluminium, Alliage ENAW-6063 (AlMg0.7Si) avec traitement thermique T66, de par sa polyvalence, c'est un des alliages les plus utilisés, principalement pour des applications où l'on désire des propriétés mécaniques modérés, dans le même temps, possédant une bonne résistance à la corrosion et de bonnes caractéristiques de solvabilité, en accord avec les normes EN12020 et EN755; embout en BragPO fixés de profil.

Garantie: 15 ans.

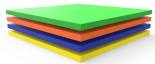

### BRAGPO

BragPO HDPE d'une couleur ou bicolore de haute densité, sans HPA. Caractérisé par son extrême légèreté et élasticité, résistante aux produits chimiques, à la corrosion, aux rayons UV (UNE EN ISO 4892), à l'inflammabilité (UNE-EN ISO 11925-2) et aux impacts (ISO 527-1). Pas d'entretien nécessaire.

Garantie: 15 ans.

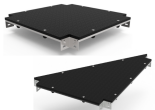

### PLATE-FORMES EN BRAGPO

Structure métallique galvanisée qui combine une résistance mécanique de l'acier et résistance à la corrosion par le zinc. Renforcé avec du BragPO d'une couleur ou bicolore de haute densité, sans HPA. Caractérisé par son extrême légèreté et élasticité, résistant aux produits chimiques, à la corrosion, aux rayons UV (UNE EN ISO 4892), à l'inflammabilité (UNE-EN ISO 11925-2) et aux impacts (ISO 527-1). Pas d'entretien nécessaire.

Renforcé avec une structure métallique galvanisée, offrant une résistance mécanique élevée ainsi qu'aux éléments corrosifs.

Garantie: 15 ans



### TOBOGGAN BRAGPO

BragPO brisé et moulé, d'une grande résistance aux produits chimiques, à la corrosion, aux rayons UV (UNE EN ISO 4892), à l'inflammabilité (UNE-EN ISO 11925-2) et aux chocs (ISO 527-1). Sans entretien.



### SIÈGE SIMPLE

En caoutchouc thermoplastique, avec renfort intérieur en aluminium. Chaînes de Ø5mm en acier galvanisé à chaud.



### ROULEMENT SPHÉRIQUE

Roulements à billes rigide, à une rangée avec joint en caoutchouc pour la fermeture, selon la norme DIN 925-1.



### FERRURES EN ACIER INOXYDABLE

Ferrures en acier inoxydable, selon la norme NF EN 10088, protégé par des capsules en polypropylène PP.



Parques Infantis  
Playground

Parques Infantiles  
Aires de Jeux

Informação sujeita a alterações sem aviso prévio.

ESPAÑA  
www.bricantel.com  
info@bricantel.com

PORTUGAL  
www.bricantel.pt  
info@bricantel.pt



@bricantel  
bricantelpt  
@bricantel

Data de exportação: 01/02/2024

**BARRE HORIZONTALE GALVANISÉ**

Tube à profil circulaire (EN 10305-3), laminé à chaud (EN 10027-1 et CR 10260), en acier galvanisé DX51D+Z275 selon la norme EN 10346.  
Garantie : 15 ans

**PIERRES D'ESCALADE (DUMMY)**

Fabriqués en polyéthylène de haute densité monocolore ou bicolore, sans HPA. C'est un polymère extrêmement léger et élastique caractérisé par sa résistance aux produits chimiques, à la corrosion, aux rayons UV (UNE EN ISO 4892), sa haute résistance à l'inflammabilité (UNE-EN ISO 11925-2) et sa résistance aux chocs (ISO 527-1). Ne nécessite aucun entretien.

**GARDE CORPS**

Fabriqués en tube d'acier inoxydable AISI 304 Ø40mm, selon la norme EN 14301, finition 2B.  
Garantie : 15 ans.

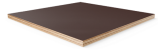
**CONTREPLAQUÉ MARITIME**

Stratifié collé avec des résines phénoliques haute pression et température, résistant aux intempéries et aux rayons UV, selon les normes EL 314-2/classe 3 (DIN 68 TS TCIL3 : BFU 100, BS 6566 PART 8 : WBP); antidérapant et bas entretien.  
Garantie : 5 ans

**ESCALIER FOLHA**

Escaliers constitués de côtés en braggo : polyéthylène de haute densité monocolore ou bicolore. En tant que polymère, il se caractérise par sa résistance aux produits chimiques et à la corrosion. Par sa capacité d'élasticité et de légèreté, il offre une résistance élevée à l'impact et est très difficile à briser. La surface antidérapante fournit une sécurité pour les enfants et sa base synthétique empêche la culture de bactéries et champignons. Il ne nécessite aucun entretien et quatre marches en contreplaqué maritime antidérapant brun et collé avec des résines phénoliques résistant aux intempéries et aux rayons UV. conformément aux normes EL 314-2/classe 3 (DIN 68 TS TCIL3 : BFU 100, BS 6566 PART 8 : WBP).

**SISTÈME DE FIXATION**

Type X - Système de fixation composé d'une base métallique fixée au sol rigide.

La base métallique est fabriquée en tôle d'acier carbone, avec un traitement anticorrosion par galvanisation par immersion à chaud d'une épaisseur comprise entre 120 et 140µm selon la norme EN ISO 1461, qui permet sa pose sans que la poutre rentre en contact direct avec le sol. Sa fixation à la poutre est réalisée par un système de serrage rapide augmentant sa longévité et facilitant son remplacement, qui sera rapide en cas de besoin.



**FONCTIONS LUDIQUES****AMUSEMENT**

En s'amusant, les enfants développent plusieurs capacités telles que des habilités physiques, émotionnelles, sociales et motrices.

**SOCIALES**

L'importance de jouer se note dans l'interaction sociale que nécessitent ces activités, réveillant en eux le sens de la convivialité et de la solidarité. En jouant, les enfants apprennent à partager, respecter, et écouter autrui. De cette manière, ils débutent leur apprentissage en vie de société.

**SE BALANCER**

Cette action aide l'enfant à développer son équilibre et lui apprend comment contrôler ses mouvements avant/arrière afin de trouver la bonne propulsion, ce qui améliore ses aptitudes psychomotrices et coordinatrices du corps. Se balancer est spécialement important pour les enfants avec une déficience au niveau de la perception visuelle, en effet cette action aide le cerveau à assimiler la vitesse et le sens des mouvements.

**GLISSER**

L'inclinaison du toboggan permet aux enfants de glisser à grande vitesse, augmentant ainsi son adrénaline. Cette sensation réveille de nouvelles émotions permettant de contrôler les mouvements, entraînant ainsi les réflexes et les capacités motrices. Cette action aide l'enfant à contrôler son comportement lors de situation inconfortable, quelle soit émotionnelle ou physique.

**CONSTRUIRE**

Certains jeux sont créés pour que les enfants se retrouvent face à des défis qui les obligent à réfléchir et construire de manière logique une solution bénéfique qui les aidera à faire face au problème apparent, qu'il soit affectif ou social.

**STIMULATION VISUELLE**

C'est au travers de cette action que les enfants vont comprendre le fonctionnement de plusieurs activités, c'est pour cela qu'il est important qu'ils développent leur perception visuelle et leur champ de vision. Grâce à ses capacités, ils pourront assimiler plus facilement des informations qui les entourent et développer plus facilement certaines capacités.

**STIMULATION TACTILE**

Certains jeux sont tactiles. En effet, en faisant appel à différentes formes et matières pour lesquelles l'enfant utilise ses mains afin de trouver une solution.

**CRÉATIVITÉ**

Rêver, inventer, penser et essayer, se sont là des actes qui aident les enfants à développer leur créativité. De cette manière, ces derniers comprennent comment utiliser leur compétence orale, motrice et cognitive dans de diverses situations.

**DÉVELOPPEMENT COGNITIF**

Un aspect important lors de la diversion des enfants, c'est le développement de leurs sens, imagination et attention. De nouveaux jeux sont essentiels pour stimuler leurs capacités à penser, comprendre et agir.

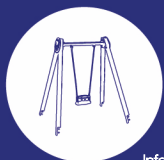

**NORMES**

EN 1176-1  
Équipements et sols d'aires de jeux  
Partie 1: Exigences de sécurité et méthodes d'essai générales



EN 1176-2  
Équipement et sols d'aires de jeux  
Partie 2: Exigences de sécurité et méthodes d'essai complémentaires spécifiques aux balançoires



EN 1176-3  
Équipement et sols d'aires de jeux  
Partie 3: Exigences de sécurité et méthodes d'essai complémentaires spécifiques aux toboggans

**CONFIDENTIALITÉ ET PROPRIÉTÉ INTELLECTUELLE**

Les informations contenues dans ce document sont confidentielles et le destinataire ne peut pas les reproduire ni permettre à des tiers de les obtenir, de les utiliser ou de les divulguer sans l'autorisation préalable et expresse de BRICANTEL.

Tous les droits de propriété intellectuelle sur les dessins et modèles présentés sont propriété exclusive de BRICANTEL, et la pratique d'un acte d'exploitation de ceux-ci sans le consentement de cette dernière, selon les termes du code de la propriété industrielle et du code du droit d'auteur et des droits voisins. La violation de l'obligation de confidentialité et / ou des droits de propriété intellectuelle de BRICANTEL peut engager à la responsabilité civile et pénale.



Parques Infantis  
Playground

Parques Infantiles  
Aires de Jeux

Informação sujeita a alterações sem aviso prévio.

ESPAÑA  
[www.bricantel.com](http://www.bricantel.com)  
[info@bricantel.com](mailto:info@bricantel.com)

PORTUGAL  
[www.bricantel.pt](http://www.bricantel.pt)  
[info@bricantel.pt](mailto:info@bricantel.pt)



@bricantel  
bricantelpt  
@bricantel

Data de exportação: 01/02/2024