



22,00 m<sup>2</sup>



0,20 m



2-12



6

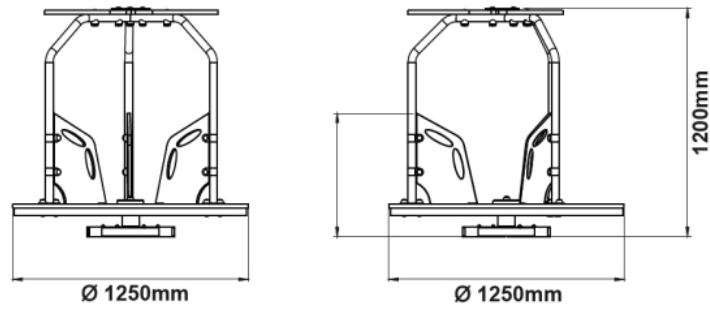
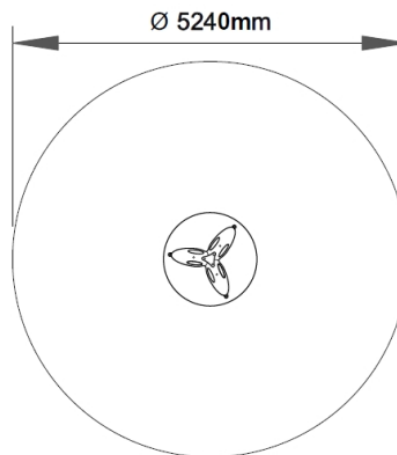

**MEDIDAS GERAIS / MEDIDAS GENERALES / GENERAL MEASURES / MESURES GÉNÉRALES**

**INSTALAÇÃO / INSTALACIÓN / INSTALLATION / INSTALLATION**

0,11m<sup>3</sup>



01:45h



2x



0,00kg



0,00kg



## DESCRIÇÃO

Equipamento BragPLAY, carrossel GIROOPTERO, (AQL -0.20m), composto por estrutura de chapa em aço galvanizado revestido com uma plataforma circular em contraplacado marítimo antiderrapante castanho. Estrutura superior em tubo Ø40mm de aço inox 304 com 3 painéis de proteção mais um ao topo decorativo, todos em bragpo. Rolamentos esféricos e cônicos e ferragens em aço eletrozincado. Fixação ao solo tipo X (aparafusar).



Medidas gerais (CxLxA): 1250x1250x1200mm  
Área de segurança: 22m<sup>2</sup> | Área livre: 5240x5240mm  
Faixa etária: 2-12 anos  
Nº de utilizadores: 6

## CARACTERÍSTICAS TÉCNICAS

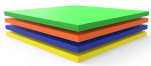

### BRAGPO

BragPO HDPE de alta densidade monocolor ou bicolor, livre de HPA. Caracterizado pela sua extrema leveza e elasticidade, resistência a produtos químicos, corrosão, raios UV (UNE EN ISO 4892), alta resistência à inflamabilidade (UNE-EN ISO 11925-2) e resistência a impactos (ISO 527-1). Não necessita de qualquer manutenção.  
Garantia: 15 anos



### ROLAMENTO ESFÉRICO

Rolamentos esféricos rígidos de uma carreira de esferas tampados com vedação em borracha para o fechamento, de acordo com a norma DIN 925-1.



### FERRAGENS EM AÇO ELETROZINCADO

Ferragens em aço eletrozincado, protegidas por cápsulas em polipropileno PP.

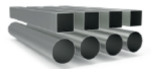

### TUBO AÇO INOX AISI 304

Tubo em aço inoxidável AISI 304, de acordo com a norma EN 14301, com acabamento 2B.  
Garantia: 15 anos.



### ROLAMENTO CÓNICO

Rolamentos de rolos cônicos rígidos de uma carreira, de acordo com a norma DIN ISO 355 e DIN 720.



### CONTRAPLACADO MARÍTIMO

Laminado colado com resinas fenólicas a alta pressão e temperatura, resistente a intempéries e raios UV, de acordo com as normas EL 314-2/classe 3 (DIN 68 TS TCIL3: Bfu 100, BS 6566 PART 8: WBP); antiderrapante e de baixa manutenção.  
Garantia: 5 anos



### SISTEMA DE FIXAÇÃO

Tipo X - Sistema de fixação composto por base metálica aparafusada ao solo rígido.

A base metálica é fabricada em chapa de aço carbono, com tratamento anticorrosivo de galvanização por imersão a quente com espessura entre 120 a 140µm de acordo com a norma EN ISO 1461, que permite a sua colocação sem que o prumo entre em contacto direto com o solo. A sua fixação ao prumo é feita por um sistema de aperto rápido aumentando a longevidade do prumo e a sua fácil e rápida substituição em caso de necessidade.



## FUNÇÕES LÚDICAS



### DIVERSÃO

Enquanto se divertem, as crianças desenvolvem imensas capacidades, tais como: habilidades físicas, emocionais, sociais e motoras.



### SOCIALIZAR

A importância de brincar reside no facto das brincadeiras promoverem a interação social, despertando-lhes o senso de convivência e solidariedade. Enquanto brincam, as crianças aprendem a partilhar, respeitar e ouvir os outros, desta forma iniciam a sua preparação para viver em sociedade.



### EQUILÍBRIO

O domínio das habilidades motoras é básico para o desenvolvimento motor da criança, desta forma é importante que a criança treine e desenvolva o seu equilíbrio.



### PUXAR

Jogos que impliquem o ato de puxar, são muito mais que simples brincadeiras. Este tipo de atividade estimula o esforço, a força de vontade e a resistência das crianças, permitindo-as começar a conhecer a sua capacidade de resistência.



### DESENVOLVIMENTO COGNITIVO

Um aspeto importante do ato de brincar, é o desenvolvimento do raciocínio, da sua imaginação e atenção. Novas brincadeiras são essenciais para estimular a capacidade de pensar, compreender e agir, desenvolvendo o sistema cognitivo.



### ROTAÇÃO/TRANSLAÇÃO

Proporciona uma sensação de liberdade. Melhora o controle do corpo, equilíbrio e coordenação.

## NORMAS



### EN 1176-1

Equipamentos e superfícies para espaços de jogo e recreio  
Parte 1: Requisitos de segurança e métodos de ensaio gerais



### EN 1176-5

Equipamentos e superfícies para espaços de jogo e recreio  
Parte 5: Requisitos de segurança e métodos de ensaio adicionais, específicos para carrosséis

## CONFIDENCIALIDADE E PROPRIEDADE INTELECTUAL

A informação contida neste documento é confidencial, não podendo o destinatário do mesmo reproduzi-la ou permitir a terceiros que a obtenham, utilizem ou divulguem sem a prévia e expressa autorização da BRICANTEL.

Todos os direitos de propriedade intelectual sobre os desenhos e modelos apresentados são da titularidade exclusiva da BRICANTEL, sendo expressamente proibida a prática de qualquer ato de exploração dos mesmos sem o consentimento desta, nos termos do código da propriedade industrial e do código do direito de autor e dos direitos conexos. A violação da obrigação de confidencialidade e/ou dos direitos de propriedade intelectual da BRICANTEL, pode dar origem a responsabilidade civil e criminal.



## DESCRIPCIÓN

Equipo BragPLAY, carrusel GIROCOPTERO, (ACL -0.20m), compuesto por estructura de acero galvanizado recubierto con una plataforma circular de contrachapado marino antideslizante marrón. Con rodamientos esféricos y cónicos. Estructura superior en tubo de acero inoxidable 304 de Ø40mm, 3 paneles de protección y uno a la parte superior de la estructura, ambos están en bragpo. Herrajes de acero electrochapado. Fijación al suelo tipo X (atornillado).



Medidas generales (LxAxA): 1250x1250x1200mm  
Área de seguridad: 22m<sup>2</sup> | Área libre: 5240x5240mm  
Grupo de edad: 2-12 años  
Número de usuarios: 6

## CARACTERÍSTICAS TÉCNICAS

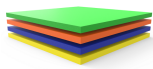

### BRAGPO

BragPO HDPE de alta densidad monocolor o bicolor, sin HPA. Caracterizado por su extrema ligereza y elasticidad, resistencia a productos químicos, corrosión, rayos UV (UNE EN ISO 4892), a la inflamabilidad (UNE-EN ISO 11925-2) y al impacto (ISO 527-1). No necesita ningún tipo de mantenimiento.  
Garantía: 15 años



### RODAMIENTO ESFÉRICO

Rodamientos esféricos rígidos de una hilera con junta de goma de cierre, según DIN 925-1.



### HERRAJES EN ACERO ELECTROCHAPADO

Herrajes en acero electrochapado, protegidos por cápsulas en polipropileno PP.



### TUBO ACERO INOX AISI 304

Tubo en acero inoxidable AISI 304, según la norma EN 14301, con refinamiento 2B.  
Garantía: 15 años.



### RODAMIENTO CÓNICO

Rodamientos de rodillos cónicos rígidos de una hilera según DIN ISO 355 y DIN 720.

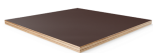

### MADERA CONTRACHAPADA MARINA

Laminado pegado con resinas fenólicas a alta presión y temperatura, resistente a la intemperie y a los rayos UV, de acuerdo con las normas EL 314-2/clase 3 (DIN 68 TS TCIL3: BFU 100, BS 6566 PART 8: WBP); antideslizante y de bajo mantenimiento.  
Garantía: 5 años



### SISTEMA DE FIJACIÓN

Tipo X - Sistema de fijación compuesto por una base metálica y atornillada al suelo rígido.

La base metálica es fabricada en chapa de acero al carbono, con tratamiento anticorrosivo de galvanización por inmersión en caliente con espesor entre 120 y 140µm de acuerdo con la norma EN ISO 1461, que permite su colocación sin que la viga entre en contacto directo con el suelo. Su fijación a la viga es hecha por un sistema de sujeción rápido aumentando la longevidad de la viga y su fácil y rápida sustitución en caso de necesidad.



## FUNCIONES DE JUEGO



### DIVERSIÓN

Mientras se divierten, los niños desarrollan una gran diversidad de capacidades, tales como: habilidades físicas, emocionales, sociales y motrices.



### SOCIALIZAR

La importancia del juego reside en que éste, promueve la interacción social, despertando en los niños la necesidad de convivencia y solidaridad. Mientras juegan, los niños aprenden a compartir, respetar y escuchar a los demás niños. Es la mejor forma de iniciar su preparación para convivir en sociedad.



### EQUILIBRIO

El dominio de las habilidades motoras es básico para el desarrollo motor de los niños, ya que de esta forma el niño ejercita y desarrolla su equilibrio.



### TIRAR

Juegos que impliquen la actividad de tirar, significan mucho más que simples diversiones. Este tipo de actividad estimula el esfuerzo, la fuerza de impulsos y la resistencia de los niños, permitiéndoles comenzar a conocer su capacidad de resistencia.



### DESARROLLO COGNITIVO

Un aspecto importante del simple acto de jugar es el desarrollo del raciocinio, de su imaginación y atención. Son esenciales nuevas diversiones, a través del juego, para estimular la capacidad de pensar, comprender y reaccionar, desarrollando así, el sistema cognitivo.



### ROTACIÓN/TRASLACIÓN

Proporciona una sensación enorme de libertad. Mejora el control del cuerpo, equilibrio y coordinación.

## NORMAS



### EN 1176-1

Equipamiento de las áreas de juego y superficies  
Parte 1: Requisitos generales de seguridad y métodos de ensayo.



### EN 1176-5

Equipamiento de las áreas de juego y superficies  
Parte 5: Requisitos de seguridad y métodos de ensayo adicionales específicos para carruseles

## CONFIDENCIALIDAD Y PROPIEDAD INTELECTUAL

La información contenida en este documento es estrictamente confidencial, no pudiendo el destinatario reproducirla o permitir a terceros que la adquieran, utilicen o divulguen sin la previa y expresa autorización de BRICANTEL.

Todos los derechos de propiedad intelectual sobre los diseños y modelos presentados son de titularidad exclusiva de BRICANTEL, estando expresamente prohibida la práctica de cualquier acto de usurpación de los mismos sin el previo consentimiento de la empresa, dentro de los términos del código de propiedad industrial y del código de derechos de autor y derechos análogos. La violación de la obligación de confidencialidad y/o de los derechos de propiedad intelectual de BRICANTEL, puede dar origen a responsabilidad civil y criminal.



## DESCRIPTION

Equipment BragPLAY, carousel GIROCOPTERO, (FFH -0.20m), composed of galvanized steel structure coated with a circular platform in marine nonslip brown plywood. With spherical and conical bearings. Upper tube structure Ø40mm 304 stainless steel, 3 protective panels and one at the top of the frame, both are in bragpo. Electro-zinc-plated steel fittings. Type X ground attachment (screw).



General measures (LxWxH): 1250x1250x1200mm  
Security area: 22m<sup>2</sup> | Free area: 5240x5240mm  
Age group: 2-12 years old  
Number of users: 6

## TECHNICAL FEATURES

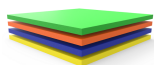

### BRAGPO

BragPO HDPE of high density in one color or bicolor, free of HPA. Characterized by its extreme lightness and elasticity, resistance to chemicals, corrosion, UV rays (UNE EN ISO 4892), to flammability (UNE-EN ISO 11925-2) and impact (ISO 527-1). It doesn't need any maintenance.  
Guarantee: 15 years.



### SPHERICAL BEARING

Single row rigid spherical ball bearings with rubber seal for closing, in accordance with DIN 925-1.



### STEEL ELECTROPLATED HARDWARE

Steel electroplated hardware, protected by polypropylene PP capsules.



### STAINLESS STEEL TUBE AISI304

Tube in stainless steel AISI 304, according to EN 14301, with finish 2B.  
Guarantee: 15 years.



### TAPERED BEARING

Single row rigid tapered roller bearings according to DIN ISO 355 and DIN 720.



### MARINE PLYWOOD

Laminated glued with phenolic resins at high pressure and temperature, weather and UV resistant, according to EL 314-2/class 3 standards (DIN 68 TS TCIL3: BFU 100, BS 6566 PART 8: WBP); non-slip and low maintenance.  
Warranty: 5 years old



### FIXATION SYSTEM

Type X - Fixation system composed of a metal base bolted to the hard ground.  
The metal base is made of carbon steel sheet, with corrosion-resistant hot-dip galvanisation treatment of between 120 and 140µm thickness according to EN ISO 1461, which allows its placement without the plumb in direct contact with the ground. Its attachment to the plumb line is made by a quick clamping system increasing the longevity of the plumb line and its easy and fast replacement in case of need.





## PLAY FUNCTIONS



### FUN

While having fun, children acquire immense abilities, from physical abilities to social interactions.



### SOCIALIZING

Socialization and imagination are necessary throughout the game. All this creates a relationship between children and awakens the sense of coexistence and solidarity.



### EQUILIBRIUM

The mastery of motor skills is basic for the child's motor development, so it's important for the child to train and develop their balance.



### PULL

Games that involve the act of pulling are more than a simple diversion. This type of activity stimulates children's effort, willpower and endurance, allowing them to begin to know their resilience.



### COGNITIVE DEVELOPMENT

An important aspect of play is the development of reasoning, imagination and attention. New games are essential to stimulate the ability to think, understand and act, developing the cognitive system.



### ROTATE

Provides a sense of freedom. Improves body control, balance and coordination.

## STANDARTS



### EN 1176-1

Playground equipment and surfacing  
Part 1: General safety requirements and test methods



### EN 1176-5

Playground equipment and surfacing  
Part 5: Additional specific safety requirements and test methods for carousels

## CONFIDENTIALITY AND INTELLECTUAL PROPERTY

The information contained in this document is confidential, and the recipient cannot reproduce it or allow third parties to obtain, use or disclose it without the prior and express authorization of BRICANTEL. All intellectual property rights over the designs and models presented are the exclusive property of BRICANTEL, and the practice of any act of exploitation thereof without the consent of the latter, under the terms of the industrial property code and the copyright code and related rights. Violation of BRICANTEL's obligation of confidentiality and / or intellectual property rights may give rise to civil and criminal liability.





## DESCRIPTION

Équipement BragPLAY, carrousel GIROCOPTERO, (HCL - 0.20m), composé d'une structure en acier galvanisé revêtu d'une plate-forme circulaire en contreplaqué maritime antidérapant brun. Avec des roulements sphériques et coniques. Structure supérieure en tube Ø40mm en acier inoxydable 304, 3 panneaux de protection et un au sommet de la structure, tous en bragpo. Ferrures en acier électrozingué. Fixation au sol type X (vissé).



Mesures générales (LxLxH) : 1250x1250x1200mm  
Zone de sécurité : 22m<sup>2</sup> | Zone libre : 5240x5240mm  
Tranche d'âge : 2-12 ans  
Nombre d'utilisateurs : 6

## CARACTÉRISTIQUES TECHNIQUES

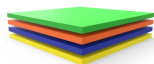

### BRAGPO

BragPO HDPE d'une couleur ou bicolore de haute densité, sans HPA. Caractérisé par son extrême légèreté et élasticité, résistante aux produits chimiques, à la corrosion, aux rayons UV (UNE EN ISO 4892), à l'inflammabilité (UNE-EN ISO 11925-2) et aux impacts (ISO 527-1). Pas d'entretien nécessaire.  
Garantie: 15 ans.



### ROULEMENT SPHÉRIQUE

Roulements à billes rigide, à une rangée avec joint en caoutchouc pour la fermeture, selon la norme DIN 925-1.



### FERRURES EN ACIER ELECTROZINGÉ

Ferrures en acier électrozingué, protégé para des capsules en polypropylène PP.



### TUBE EN ACIER INOXYDABLE AISI 304

Tube en acier inoxydable AISI 304, en accord avec la norme EN 14301, avec finition 2B.  
Garantie: 15 ans.



### ROULEMENT CONIQUE

Roulements à rouleaux coniques rigides à une rangée, conformément aux normes DIN ISO 355 et DIN 720.

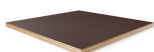

### CONTREPLAQUÉ MARITIME

Stratifié collé avec des résines phénoliques haute pression et température, résistant aux intempéries et aux rayons UV, selon les normes EL 314-2/classe 3 (DIN 68 TS TCIL3 : BFU 100, BS 6566 PART 8 : WBP); antidérapant et bas entretien.  
Garantie : 5 ans



### SISTÈME DE FIXATION

Type X - Système de fixation composé d'une base métallique fixée au sol rigide.

La base métallique est fabriquée en tôle d'acier carbone, avec un traitement anticorrosion par galvanisation par immersion à chaud d'une épaisseur comprise entre 120 et 140µm selon la norme EN ISO 1461, qui permet sa pose sans que la poutre rentre en contact direct avec le sol. Sa fixation à la poutre est réalisée par un système de serrage rapide augmentant sa longévité et facilitant son remplacement, qui sera rapide en cas de besoin.



## FONCTIONS LUDIQUES



### AMUSEMENT

En s'amusant, les enfants développent plusieurs capacités telles que des habilités physiques, émotionnelles, sociales et motrices.



### SOCIALES

L'importance de jouer se note dans l'interaction sociale que nécessitent ces activités, réveillant en eux le sens de la convivialité et de la solidarité. En jouant, les enfants apprennent à partager, respecter, et écouter autrui. De cette manière, ils débutent leur apprentissage en vie de société.



### ÉQUILIBRE

Dominer sa motricité est la base pour accroître la croissance de l'enfant, c'est pour cela qu'il est important que les jeunes entraînent leur équilibre.



### TIRER

Les jeux qui impliquent l'acte de tirer ne sont pas qu'une distraction. Ces activités aiguisent la volonté et la résistance. De cette manière, les enfants en apprennent davantage sur leur capacité à résister.



### DÉVELOPPEMENT COGNITIF

Un aspect importante lors de la diversion des enfants, c'est le développement de leurs sens, imagination et attention. De nouveaux jeux sont essentiels pour stimuler leurs capacités à penser, comprendre et agir.



### TOURNOYER

Donnant une sensation de liberté, ce jeu améliore le contrôle du corps, l'équilibre et la coordination.

## NORMES



### EN 1176-1

Équipements et sols d'aires de jeux  
Partie 1: Exigences de sécurité et méthodes d'essai générales



### EN 1176-5

Équipements et sols d'aires de jeux  
Partie 5: Exigences de sécurité et méthodes d'essai complémentaires spécifiques aux manèges

## CONFIDENTIALITÉ ET PROPRIÉTÉ INTELLECTUELLE

Les informations contenues dans ce document sont confidentielles et le destinataire ne peut pas les reproduire ni permettre à des tiers de les obtenir, de les utiliser ou de les divulguer sans l'autorisation préalable et expresse de BRICANTEL.

Tous les droits de propriété intellectuelle sur les dessins et modèles présentés sont propriété exclusive de BRICANTEL, et la pratique d'un acte d'exploitation de ceux-ci sans le consentement de cette dernière, selon les termes du code de la propriété industrielle et du code du droit d'auteur et des droits voisins. La violation de l'obligation de confidentialité et / ou des droits de propriété intellectuelle de BRICANTEL peut engager à la responsabilité civile et pénale.

