

28,00 m²



0,15 m



3-14



1



MEDIDAS GERAIS / MEDIDAS GENERALES / GENERAL MEASURES / MESURES GÉNÉRALES

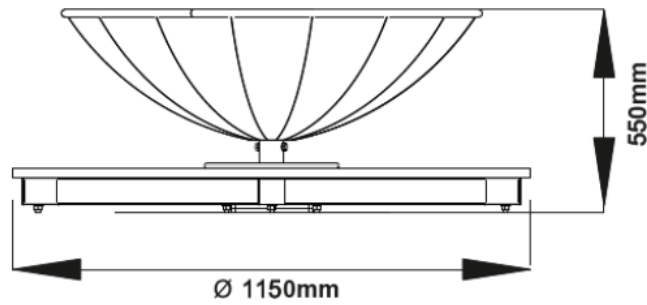

INSTALAÇÃO / INSTALACIÓN / INSTALLATION / INSTALLATION

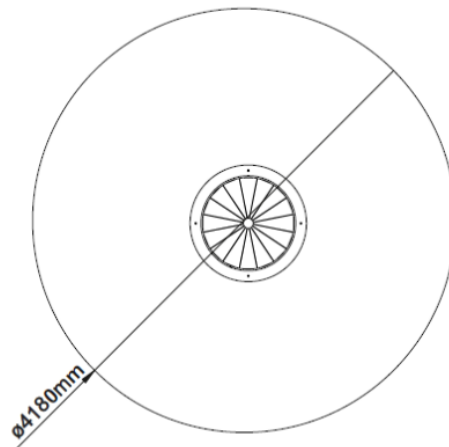

0,32m³



02:00h



2x



23,00kg



66,00kg



DESCRIÇÃO

Equipamento BragPLAY, giratório CONCHA, (AQL -0.15m), acessível a crianças com mobilidade reduzida, composto por estrutura em chapa e tubo Ø30mm em aço inox AISI 304, plataforma circular em contraplacado marítimo antiderrapante castanho localizado ao nível do solo, aros circulares em Bragpo, cardan e ferragens em aço inox A2. Fixação ao solo tipo Y (chumbar).



Medidas gerais (CxLxA): 1150x1150x550mm
Área de segurança: 28m² | Área livre: 4180x4180mm
Faixa etária: 3-14 anos
Nº de utilizadores: 1

CARACTERÍSTICAS TÉCNICAS

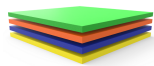

BRAGPO

BragPO HDPE de alta densidade monocolor ou bicolor, livre de HPA. Caracterizado pela sua extrema leveza e elasticidade, resistência a produtos químicos, corrosão, raios UV (UNE EN ISO 4892), alta resistência à inflamabilidade (UNE-EN ISO 11925-2) e resistência a impactos (ISO 527-1). Não necessita de qualquer manutenção.

Garantia: 15 anos



FERRAGENS EM AÇO INOX A2

Ferragens em aço inox A2, de acordo com a norma NF EN 10088, protegidas por cápsulas em polipropileno PP.



TUBO AÇO INOX AISI 304

Tubo em aço inoxidável AISI 304, de acordo com a norma EN 14301, com acabamento 2B.

Garantia: 15 anos.

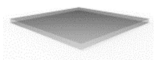

CHAPA EM AÇO INOX AISI304

Chapa de aço lisa (EN 10327) de aço laminado a quente (EN 10027-1 e CR 10260), em aço inoxidável AISI 304, de acordo com a norma EN 14301, com acabamento 2B.

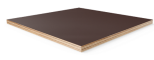

CONTRAPLACADO MARÍTIMO

Laminado colado com resinas fenólicas a alta pressão e temperatura, resistente a intempéries e raios UV, de acordo com as normas EL 314-2/classe 3 (DIN 68 TS TCIL3: BFU 100, BS 6566 PART 8: WBP); antiderrapante e de baixa manutenção.

Garantia: 5 anos



SISTEMA DE FIXAÇÃO

Tipo Y - Sistema de fixação composto por base metálica embutida ou por prumos aplicado diretamente no solo e chumbada com betão.

A base metálica embutida é fabricada em chapa de aço carbono, com tratamento anticorrosivo de galvanização por imersão a quente com espessura entre 120 a 140µm de acordo com a norma EN ISO 1461, que permite a sua colocação sem que o prumo entre em contacto direto com o solo. A sua fixação ao prumo é feita por um sistema de aperto rápido aumentando a longevidade do prumo e a sua fácil e rápida substituição em caso de necessidade.



FUNÇÕES LÚDICAS



DIVERSÃO

Enquanto se divertem, as crianças desenvolvem imensas capacidades, tais como: habilidades físicas, emocionais, sociais e motoras.



EQUILÍBRIO

O domínio das habilidades motoras é básico para o desenvolvimento motor da criança, desta forma é importante que a criança treine e desenvolva o seu equilíbrio.



DESCANSAR

O descanso é essencial para que o cérebro das crianças possa repousar. Fornece energia para possam brincar e a aprender nas mais diversas atividades.



ESTIMULAÇÃO VISUAL

É através da estimulação visual, que as crianças adquirem estímulos essenciais que vão impulsionar o desenvolvimento do seu campo visual. Assim, é essencial que estas desenvolvam uma visão funcional, que as permita brincar, socializar para interiorizar informações do meio que as rodeia e desenvolver competências.



DESENVOLVIMENTO COGNITIVO

Um aspeto importante do ato de brincar, é o desenvolvimento do raciocínio, da sua imaginação e atenção. Novas brincadeiras são essenciais para estimular a capacidade de pensar, compreender e agir, desenvolvendo o sistema cognitivo.



ROTAÇÃO/TRANSLAÇÃO

Proporciona uma sensação de liberdade. Melhora o controle do corpo, equilíbrio e coordenação.

NORMAS



EN 1176-1

Equipamentos e superfícies para espaços de jogo e recreio
Parte 1: Requisitos de segurança e métodos de ensaio gerais



EN 1176-5

Equipamentos e superfícies para espaços de jogo e recreio
Parte 5: Requisitos de segurança e métodos de ensaio adicionais, específicos para carrosséis

CONFIDENCIALIDADE E PROPRIEDADE INTELECTUAL

A informação contida neste documento é confidencial, não podendo o destinatário do mesmo reproduzi-la ou permitir a terceiros que a obtenham, utilizem ou divulguem sem a prévia e expressa autorização da BRICANTEL.

Todos os direitos de propriedade intelectual sobre os desenhos e modelos apresentados são da titularidade exclusiva da BRICANTEL, sendo expressamente proibida a prática de qualquer ato de exploração dos mesmos sem o consentimento desta, nos termos do código da propriedade industrial e do código do direito de autor e dos direitos conexos. A violação da obrigação de confidencialidade e/ou dos direitos de propriedade intelectual da BRICANTEL, pode dar origem a responsabilidade civil e criminal.



DESCRIPCIÓN

Equipo BragPLAY, giratorio CONCHA, (ACL -0.15m), accesible a niños con movilidad reducida, compuesto por estructura en chapa y tubo de Ø30mm en acero inoxidable AISI 304, plataforma circular en madera contrachapada marina antideslizante marrón ubicada al nivel del suelo, Marcos circulares en Bragpo y herrajes en acero inoxidable A2. Fijación al suelo tipo Y (hormigonado).



Medidas generales (LxAxA): 1150x1150x550mm
Área de seguridad: 28m² | Área libre: 4180x4180mm
Grupo de edad: 3-14 años
Número de usuarios: 1

CARACTERÍSTICAS TÉCNICAS

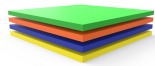

BRAGPO

BragPO HDPE de alta densidad monocolor o bicolor, sin HPA. Caracterizado por su extrema ligereza y elasticidad, resistencia a productos químicos, corrosión, rayos UV (UNE EN ISO 4892), a la inflamabilidad (UNE-EN ISO 11925-2) y al impacto (ISO 527-1). No necesita ningún tipo de mantenimiento.
Garantía: 15 años



HERRAJES EN ACERO INOX A2

Herrajes en acero inox A2, según NF EN 10088, protegidos por cápsulas en polipropileno PP.



TUBO ACERO INOX AISI 304

Tubo en acero inoxidable AISI 304, según la norma EN 14301, con refinamiento 2B.
Garantía: 15 años.

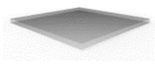

CHAPA EN ACERO INOX AISI304

Chapa en acero lisa (EN 10327) acero laminado en caliente (EN 10027-1 y CR 10260), en acero inoxidable AISI 304, según norma EN 14301, con refinamiento 2B.



MADERA CONTRACHAPADA MARINA

Laminado pegado con resinas fenólicas a alta presión y temperatura, resistente a la intemperie y a los rayos UV, de acuerdo con las normas EL 314-2/clase 3 (DIN 68 TS TCIL3: BFU 100, BS 6566 PART 8: WBP); antideslizante y de bajo mantenimiento.
Garantía: 5 años



SISTEMA DE FIJACIÓN

Tipo Y - Sistema de fijación compuesto por una base metálica incorporada o hormigonado aplicado directamente al suelo y plomada con hormigón.

La base metálica incorporada está fabricada en chapa de acero carbono, con tratamiento anticorrosivo por inmersión en caliente de 120 a 140µm de espesor según EN ISO 1461, que permite su colocación sin que el poste entre en contacto directo con el suelo. Su fijación a al poste se realiza por un sistema de sujeción rápido aumentando la longevidad de la viga y su fácil y rápida sustitución en caso de necesidad.



FUNCIONES DE JUEGO



DIVERSIÓN

Mientras se divierten, los niños desarrollan una gran diversidad de capacidades, tales como: habilidades físicas, emocionales, sociales y motrices.



EQUILIBRIO

El dominio de las habilidades motoras es básico para el desarrollo motor de los niños, ya que de esta forma el niño ejercita y desarrolla su equilibrio.



DESCANSAR

El descanso es esencial para que el cerebro de los niños pueda reposar. Les suministra nueva energía para poder continuar jugando y aprender en las más variadas actividades.



ESTIMULACIÓN VISUAL

A través de la estimulación visual, los niños adquieren incentivos esenciales que van a aumentar el desarrollo de su campo visual. De esta manera, es primordial que ellos desarrollen una visión funcional que les permita jugar y socializar para interiorizar informaciones del medio que los rodea, así como a desarrollar capacidades.



DESARROLLO COGNITIVO

Un aspecto importante del simple acto de jugar es el desarrollo del raciocinio, de su imaginación y atención. Son esenciales nuevas diversiones, a través del juego, para estimular la capacidad de pensar, comprender y reaccionar, desarrollando así, el sistema cognitivo.



ROTACIÓN/TRASLACIÓN

Proporciona una sensación enorme de libertad. Mejora el control del cuerpo, equilibrio y coordinación.

NORMAS



EN 1176-1

Equipamiento de las áreas de juego y superficies
Parte 1: Requisitos generales de seguridad y métodos de ensayo.



EN 1176-5

Equipamiento de las áreas de juego y superficies
Parte 5: Requisitos de seguridad y métodos de ensayo adicionales específicos para carruseles

CONFIDENCIALIDAD Y PROPIEDAD INTELECTUAL

La información contenida en este documento es estrictamente confidencial, no pudiendo el destinatario reproducirla o permitir a terceros que la adquieran, utilicen o divulguen sin la previa y expresa autorización de BRICANTEL.

Todos los derechos de propiedad intelectual sobre los diseños y modelos presentados son de titularidad exclusiva de BRICANTEL, estando expresamente prohibida la práctica de cualquier acto de usurpación de los mismos sin el previo consentimiento de la empresa, dentro de los términos del código de propiedad industrial y del código de derechos de autor y derechos análogos. La violación de la obligación de confidencialidad y/o de los derechos de propiedad intelectual de BRICANTEL, puede dar origen a responsabilidad civil y criminal.



DESCRIPTION

BragPLAY equipment, CONCHA turntable, (AQL -0.15m), accessible to children with reduced mobility, consisting of plate and pipe structure Ø30mm in AISI 304 stainless steel, circular platform in brown non-slip marine plywood located at ground level, circular hoops in Bragpo and fittings in A2 stainless steel. Type Y anchorage (concreting).



General measures (LxWxW): 1150x1150x550mm
Security area: 28m² | Free area: 4180x4180mm
Age group: 3-14 years old
Number of users: 1

TECHNICAL FEATURES

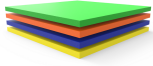

BRAGPO

BragPO HDPE of high density in one color or bicolor, free of HPA. Characterized by its extreme lightness and elasticity, resistance to chemicals, corrosion, UV rays (UNE EN ISO 4892), to flammability (UNE-EN ISO 11925-2) and impact (ISO 527-1). It doesn't need any maintenance.
Guarantee: 15 years.



STAINLESS STEEL HARDWARE A2

Stainless steel A2, in accordance with NF EN 10088, protected by polypropylene PP capsules.

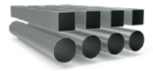

STAINLESS STEEL TUBE AISI304

Tube in stainless steel AISI 304, according to EN 14301, with finish 2B.
Guarantee: 15 years.

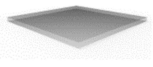

STAINLESS STEEL PLATE AISI304

Smooth stainless steel plate (EN 10327) hot rolled steel (EN 10027-1 e CR 10260), with stainless steel AISI 304, according to EN 14301, with finish 2B.

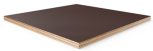

MARINE PLYWOOD

Laminated glued with phenolic resins at high pressure and temperature, weather and UV resistant, according to EL 314-2/class 3 standards (DIN 68 TS TCIL3: BFU 100, BS 6566 PART 8: WBP); non-slip and low maintenance.
Warranty: 5 years old



FIXATION SYSTEM

Type Y - Fixation system composed of built-in metal base or plumbing applied directly to the ground and concrete sinker. The built-in metal base is made of carbon steel sheet, with corrosion-resistant hot-dip galvanisation treatment of between 120 and 140µm thickness according to EN ISO 1461, which allows its placement without the plumb in direct contact with the ground. Its attachment to the plumb line is made by a quick clamping system increasing the longevity of the plumb line and its easy and fast replacement in case of need.



PLAY FUNCTIONS



FUN

While having fun, children acquire immense abilities, from physical abilities to social interactions.



EQUILIBRIUM

The mastery of motor skills is basic for the child's motor development, so it's important for the child to train and develop their balance.



REST

Rest is essential for the children's brain to relax. It provides energy for them to play and learn in the most diverse activities.



VISUAL STIMULATION

It's through visual stimulation that children acquire essential stimuli that will boost the development of their visual field. Thus, it's essential that they develop a functional vision that allows them to play, socialize to internalize information from their surroundings and develop skills.



COGNITIVE DEVELOPMENT

An important aspect of play is the development of reasoning, imagination and attention. New games are essential to stimulate the ability to think, understand and act, developing the cognitive system.



ROTATE

Provides a sense of freedom. Improves body control, balance and coordination.

STANDARTS



EN 1176-1

Playground equipment and surfacing
Part 1: General safety requirements and test methods



EN 1176-5

Playground equipment and surfacing
Part 5: Additional specific safety requirements and test methods for carousels

CONFIDENTIALITY AND INTELLECTUAL PROPERTY

The information contained in this document is confidential, and the recipient cannot reproduce it or allow third parties to obtain, use or disclose it without the prior and express authorization of BRICANTEL. All intellectual property rights over the designs and models presented are the exclusive property of BRICANTEL, and the practice of any act of exploitation thereof without the consent of the latter, under the terms of the industrial property code and the copyright code and related rights. Violation of BRICANTEL's obligation of confidentiality and / or intellectual property rights may give rise to civil and criminal liability.



DESCRIPTION

Equipement BragPLAY, pivotant CONCHA, (HCL -0.15m), accessible aux enfants à mobilité réduite, composé d'une structure en tôle et en tube Ø30mm en acier inoxydable AISI 304, plate-forme circulaire en contreplaqué marin antidérapant marron situé au niveau du sol, décoratifs circulaires en Bragpo et ferrures en acier inoxydable A2. Fixation au sol de type Y (bétonné).



Mesures générales (LxLxH) : 1150x1150x550mm
Zone de sécurité : 28m² | Surface libre : 4180x4180mm
Tranche d'âge : 3-14 ans
Nombre d'utilisateurs : 1

CARACTÉRISTIQUES TECHNIQUES

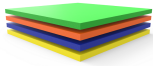

BRAGPO

BragPO HDPE d'une couleur ou bicolore de haute densité, sans HPA. Caractérisé par son extrême légèreté et élasticité, résistante aux produits chimiques, à la corrosion, aux rayons UV (UNE EN ISO 4892), à l'inflammabilité (UNE-EN ISO 11925-2) et aux impacts (ISO 527-1). Pas d'entretien nécessaire.
Garantie: 15 ans.



FERRURES EN ACIER INOXYDABLE A2

Ferrures en acier inoxydable A2, selon la norme NF EN 10088, protégé par des capsules en polypropylène PP.



TUBE EN ACIER INOXYDABLE AISI 304

Tube en acier inoxydable AISI 304, en accord avec la norme EN 14301, avec finition 2B.
Garantie: 15 ans.

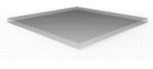

TÔLE EN ACIER INOXYDABLE AISI 304

Tôle en acier inoxydable (EN 10327), en acier laminé à chaud (EN 10027-1 et CR 10260), en acier inoxydable AISI 304, en accord avec la norme EN 14301, avec finition 2B.



CONTREPLAQUÉ MARITIME

Stratifié collé avec des résines phénoliques haute pression et température, résistant aux intempéries et aux rayons UV, selon les normes EL 314-2/classe 3 (DIN 68 TS TCIL3 : BFU 100, BS 6566 PART 8 : WBP); antidérapant et bas entretien.
Garantie : 5 ans



SISTÈME DE FIXATION

Type Y - Système de fixation composé d'une base métallique encastrée ou d'une poutre appliquée directement au sol et bétonnée.

La base métallique encastrée est fabriquée en tôle d'acier carbone, avec un traitement anticorrosion par galvanisation par immersion à chaud d'une épaisseur comprise entre 120 et 140µm selon la norme EN ISO 1461, qui permet sa pose sans que la poutre rentre en contact direct avec le sol. Sa fixation à la poutre est réalisée par un système de serrage rapide augmentant sa longévité et facilitant son remplacement, qui sera rapide en cas de besoin.



FONCTIONS LUDIQUES



AMUSEMENT

En s'amusant, les enfants développent plusieurs capacités telles que des habilités physiques, émotionnelles, sociales et motrices.



ÉQUILIBRE

Dominer sa motricité est la base pour accroître la croissance de l'enfant, c'est pour cela qu'il est important que les jeunes entraînent leur équilibre.



SE REPOSER

Le repos est essentiel afin que le cerveau des enfants se relaxe. Cela leur permettra de se requinquer afin qu'ils puissent jouer et apprendre de nouvelles activités.



STIMULATION VISUELLE

C'est au travers de cette action que les enfants vont comprendre le fonctionnement de plusieurs activités, c'est pour cela qu'il est important qu'ils développent leur perception visuelle et leur champ de vision. Grâce à ses capacités, ils pourront assimiler plus facilement des informations qui les entourent et développer plus facilement certaines capacités.



DÉVELOPPEMENT COGNITIF

Un aspect importante lors de la diversion des enfants, c'est le développement de leurs sens, imagination et attention. De nouveaux jeux sont essentiels pour stimuler leurs capacités à penser, comprendre et agir.



TOURNOYER

Donnant une sensation de liberté, ce jeu améliore le contrôle du corps, l'équilibre et la coordination.

NORMES



EN 1176-1

Équipements et sols d'aires de jeux
Partie 1: Exigences de sécurité et méthodes d'essai générales



EN 1176-5

Équipements et sols d'aires de jeux
Partie 5: Exigences de sécurité et méthodes d'essai complémentaires spécifiques aux manèges

CONFIDENTIALITÉ ET PROPRIÉTÉ INTELLECTUELLE

Les informations contenues dans ce document sont confidentielles et le destinataire ne peut pas les reproduire ni permettre à des tiers de les obtenir, de les utiliser ou de les divulguer sans l'autorisation préalable et expresse de BRICANTEL.

Tous les droits de propriété intellectuelle sur les dessins et modèles présentés sont propriété exclusive de BRICANTEL, et la pratique d'un acte d'exploitation de ceux-ci sans le consentement de cette dernière, selon les termes du code de la propriété industrielle et du code du droit d'auteur et des droits voisins. La violation de l'obligation de confidentialité et / ou des droits de propriété intellectuelle de BRICANTEL peut engager à la responsabilité civile et pénale.

