

Tolerância Geral: ± 5%



75,00 m²



2,00 m





0.5-12



25

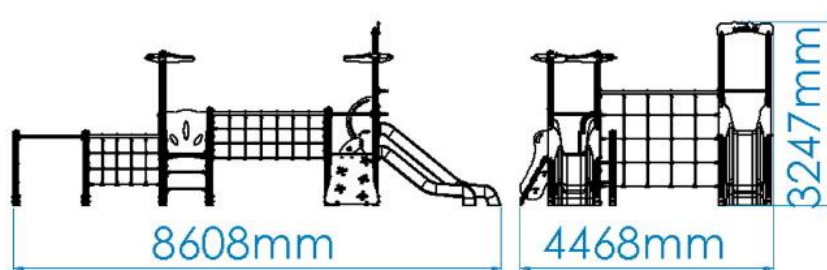

MEDIDAS GERAIS / MEDIDAS GENERALES / GENERAL MEASURES / MESURES GÉNÉRALES

INSTALAÇÃO / INSTALACIÓN / INSTALLATION / INSTALLATION

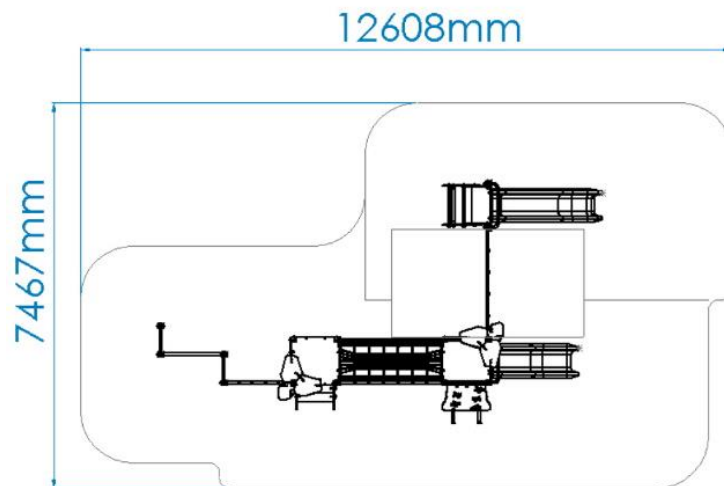
		
1	47,00m ²	0,90m
2	20,00m ²	1,30m
3	8,00m ²	2,00m

 2,10m³

16:30h



2x



35,00kg



500,00kg



DESCRIÇÃO

Equipamento BragPLAY, Danaus Park ABIBE (AQL - 2.00m), composto por:



-2 torres Nuvem com Árvore em Bragpo (AQL - 0.90m), prumos em madeira 90x90mm cor cerejeira e plataformas com estrutura galvanizada revestida a contraplacado marítimo antiderrapante castanho;

-1 Mini torres Simples (AQL - 1,30m), prumos em madeira 90x90mm cor cerejeira e plataformas com estrutura galvanizada revestida a contraplacado marítimo antiderrapante castanho.

Ligações:

-1 ponte Mineira suspensa (AQL - 1,30m) com quatro degraus em Bragpo, fabricada com cordas reforçadas em aço revestido por fibras de polipropileno Ø16mm e corrimãos em tubo Ø50mm em aço inox;

-1 rede Vertical (AQL - 2.00m) em teia de corda reforçada em aço revestido por fibras de polipropileno Ø16mm com apoio superior em tubo Ø50mm em aço inox;

-1 rede Vertical (AQL - 1.10m) em teia de corda reforçada em aço revestido por fibras de polipropileno Ø16mm com apoio superior em tubo Ø50mm em aço inox.

Vias de acesso:

-1 rampa de escalada Danaus (AQL - 0.90m) em contraplacado marítimo antiderrapante castanho com seis pedras de escada Dummy em Bragpo;

-1 escorrega Savana (AQL - 1,30m) em Bragpo rotomoldado com painel de resguardo em Bragpo;

-1 escorrega Savana (AQL - 0.90m) em Bragpo rotomoldado com painel de resguardo em Bragpo;

-1 escada Folha (AQL - 0.90m) com laterais em Bragpo e quatro degraus em contraplacado marítimo antiderrapante castanho;

-2 Escadotes em Madeira com dois degraus.

Complementos:

-1 par de pegas em Bragpo;

-2 guarda corpos curvos em tubo Ø40mm em aço inox;

-2 guarda corpos retos em tubo Ø40mm em aço inox;

-1 painel barreira de proteção com quatro rasgos em Bragpo.

Ferragens em aço eletrozincado.

Fixação ao solo tipo X (aparafusar).

Medidas gerais (CxLxA): 8608x4468x3247mm

Área de segurança: 75m² | Área livre: 7467x12608mm

Faixa etária: 0.5-12 anos

Nº de utilizadores: 25

CARACTERÍSTICAS TÉCNICAS



PRUMO MADEIRA

Perfil tipo trevo de 90x90mm com quatro frisos em pinho laminado, com tratamento autoclave e acabamento final a tinta de base aquosa, com cor cerejeira, especialmente desenvolvida para proteger a madeira de humidades, intempéries, raios U.V. e aparecimento de fungos e bolores; Tacos em BragPO aparafusados.

Garantia: 10 anos

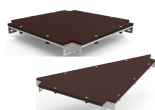

PLATAFORMAS EM CONTRAPLACADO MARÍTIMO

Plataformas quadradas ou triangulares em contraplacado marítimo, laminado colado com resinas fenólicas a alta pressão e temperatura, resistente a intempéries e raios UV, de acordo com as normas EL 314-2/classe 3 (DIN 68 TS TCIL3: BFU 100, BS 6566 PART 8: WBP); antiderrapante e de baixa manutenção.

Reforçada com uma estrutura metálica galvanizada, conferindo uma elevada resistência mecânica bem como resistência aos elementos corrosivos.

Garantia: 5 anos



FERRAGENS EM AÇO ELETROZINCADO

Ferragens em aço eletrozincado, protegidas por cápsulas em polipropileno PP.



**REDES E COMPONENTES DE FIXAÇÃO**

Cordas Ø16/18mm reforçadas em aço galvanizado a quente revestido por fibras de polipropileno com tratamento térmico de indução para reforço da ligação entre a corda e o aço, aumentando significativamente a sua resistência. Acessórios de ligação e fixação em plástico BragPO HDPE com proteção U.V., elementos de fixação em aço galvanizado a quente. Garantia: 5 anos

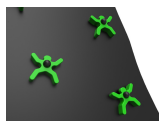
**PEDRAS ESCALADA (DUMMY)**

Fabricados em polietileno de alta densidade monocolor ou bicolor, livre de HPA. É um polímero de extrema leveza e elasticidade caracterizado pela resistência a produtos químicos, corrosão, raios UV (UNE EN ISO 4892), alta resistência à inflamabilidade (UNE-EN ISO 11925-2) e resistência a impactos (ISO 527-1). Impossibilita o cultivo tanto de bactérias como de fungos. Não necessita de qualquer manutenção.

**GUARDA CORPOS**

Fabricados em tubo Ø40mm em aço inoxidável AISI 304, de acordo com a norma EN 14301, com acabamento 2B. Garantia: 15 anos.

**PONTE INDIANA SUSPENSA**

Ponte em rede fabricada com cordas Ø16mm reforçadas em aço revestido por fibras de polipropileno, acessórios de ligação e fixação em plástico bragpo com protecção U.V., elementos de fixação em aço galvanizado a quente e corrimãos em tubo Ø50mm em aço inoxidável AISI 304, de acordo com a norma EN 14301, com acabamento 2B. Garantia: 15 anos.

**ESCADA FOLHA**

Escadas constituídas com laterais em bragpo: polietileno de alta densidade monocolor ou bicolor. Por ser um polímero é caracterizado pela sua resistência a produtos químicos e à corrosão. Pela sua capacidade de elasticidade e leveza, oferece alta resistência ao impacto, sendo muito difícil quebrar. A superfície antiderrapante fornece segurança para as crianças e a sua base sintética impede o cultivo de bactérias e fungos. Não necessita de qualquer manutenção e quatro degraus em contraplacado marítimo antiderrapante castanho e colado com resinas fenólicas resistentes as intempéries e raios UV. em conformidade com as normas EL 314-2/classe 3 (DIN 68 TS TCIL3: BFU 100, BS 6566 PART 8 : WBP).

**SISTEMA DE FIXAÇÃO**

Tipo X - Sistema de fixação composto por base metálica aparafusada ao solo rígido.

A base metálica é fabricada em chapa de aço carbono, com tratamento anticorrosivo de galvanização por imersão a quente com espessura entre 120 a 140µm de acordo com a norma EN ISO 1461, que permite a sua colocação sem que o prumo entre em contacto direto com o solo. A sua fixação ao prumo é feita por um sistema de aperto rápido aumentando a longevidade do prumo e a sua fácil e rápida substituição em caso de necessidade.



FUNÇÕES LÚDICAS



DIVERSÃO

Enquanto se divertem, as crianças desenvolvem imensas capacidades, tais como: habilidades físicas, emocionais, sociais e motoras.



SOCIALIZAR

A importância de brincar reside no facto das brincadeiras promoverem a interação social, despertando-lhes o senso de convivência e solidariedade. Enquanto brincam, as crianças aprendem a partilhar, respeitar e ouvir os outros, desta forma iniciam a sua preparação para viver em sociedade.



ESCORREGAR

A superfície inclinada permite que a criança deslize a grande velocidade, aumentando a sua adrenalina. Esta sensação desperta novas emoções, permitindo controlar os movimentos, exercitando os reflexos e as habilidades motoras. Este movimento ajuda a criança a controlar o seu comportamento em situações de desconforto emocional e/ou físico.



TREPAR

Desenvolve a coordenação motora das crianças, o controlo do próprio corpo, o equilíbrio e resistência. Esta atividade ajuda a criança a coordenar os movimentos das mãos e dos pés com o auxílio da sua percepção visual e cognitiva.



CONSTRUIR

Alguns jogos e brincadeiras, são desenvolvidos para que as crianças se deparem com desafios que as obriguem a pensar e construir uma solução benéfica que as ajude a encarar a problemática quer a nível emocional quer a nível social.



SALTAR

Exercícios que estimulem o ato de saltar são extremamente benéficos para a saúde das crianças. Saltar estimula o aumento da massa e resistência muscular.



EQUILÍBRIO

O domínio das habilidades motoras é básico para o desenvolvimento motor da criança, desta forma é importante que a criança treine e desenvolva o seu equilíbrio.



ESTIMULAÇÃO VISUAL

É através da estimulação visual, que as crianças adquirem estímulos essenciais que vão impulsionar o desenvolvimento do seu campo visual. Assim, é essencial que estas desenvolvam uma visão funcional, que as permita brincar, socializar para interiorizar informações do meio que as rodeia e desenvolver competências.



MEMÓRIA

Brincar, para além de todos os benefícios físicos que confere à saúde das crianças, estimula também a memória, sendo que esta desempenha um papel fundamental no desenvolvimento cognitivo, social e emocional.



ESTIMULAÇÃO TÁTIL

É através do ato de brincar que se consegue estimular o sistema tátil de uma forma fácil e simples, a introdução de objetos com diferentes texturas permite que as crianças comecem a utilizar as mãos e desta forma, despertar a sua percepção sensorial tátil.



**CRIATIVIDADE**

São ações como inventar, sonhar, pensar e experimentar, que desenvolvem a criatividade das crianças. Dessa forma, estas passam a compreender e a usar as suas competências orais, motoras e cognitivas nas mais diversas atividades.

**DESENVOLVIMENTO COGNITIVO**

Um aspeto importante do ato de brincar, é o desenvolvimento do raciocínio, da sua imaginação e atenção. Novas brincadeiras são essenciais para estimular a capacidade de pensar, compreender e agir, desenvolvendo o sistema cognitivo.

NORMAS**EN 1176-1**

Equipamentos e superfícies para espaços de jogo e recreio
Parte 1: Requisitos de segurança e métodos de ensaio gerais

**EN 1176-3**

Equipamentos e superfícies para espaços de jogo e recreio
Parte 3: Requisitos de segurança específicos adicionais e métodos de ensaio para escorregas

CONFIDENCIALIDADE E PROPRIEDADE INTELECTUAL

A informação contida neste documento é confidencial, não podendo o destinatário do mesmo reproduzi-la ou permitir a terceiros que a obtenham, utilizem ou divulguem sem a prévia e expressa autorização da BRICANTEL.

Todos os direitos de propriedade intelectual sobre os desenhos e modelos apresentados são da titularidade exclusiva da BRICANTEL, sendo expressamente proibida a prática de qualquer ato de exploração dos mesmos sem o consentimento desta, nos termos do código da propriedade industrial e do código do direito de autor e dos direitos conexos. A violação da obrigação de confidencialidade e/ou dos direitos de propriedade intelectual da BRICANTEL, pode dar origem a responsabilidade civil e criminal.



DESCRIPCIÓN

Equipamiento BragPLAY, Danaus Park ABIBE (HIC - 2.00m). compuesto por:



- 2 Torres Nube con Árbol en Bragpo (HIC - 0.90m), postes de madera 90x90mm color cerezo y plataformas con estructura galvanizada revestida en contrachapado marino antideslizante marrón;
- 1 Mini Torres Simple (HIC - 1,30m), postes de madera 90x90mm color cerezo y plataformas con estructura galvanizada revestida en contrachapado marino antideslizante marrón.

Enlaces:

- 1 Puente Minero suspendido (HIC - 1,30m) con cuatro peldaños en Bragpo, fabricado con cuerdas reforzadas en acero revestido por fibras de polipropileno Ø16mm y pasamanos en tubo Ø50mm de acero inox;
- 1 Red Vertical (HIC - 2.00m) de tejido de cuerda reforzada en acero revestido por fibras de polipropileno Ø16mm con apoyo superior en tubo Ø50mm de acero inox;
- 1 Rede Vertical (HIC - 1.10m) en tejido de cuerda reforzada en acero revestido por fibras de polipropileno Ø16mm con apoyo superior en tubo Ø50mm de acero inox.

Viás de acceso:

- 1 Rampa de Escalada Danaus (HIC - 0.90m) en contrachapado marino antideslizante marrón compuesto por seis piedras de escalda Dummy en Bragpo;
- 1 Tobogán Sabana (HIC - 1,30m) en Bragpo rotomoldado con panel de protección en Bragpo;
- 1 Tobogán Sabana (HIC - 0.90m) en Bragpo rotomoldado con panel de protección en Bragpo;
- 1 Escalera Hoja (HIC - 0.90m) con laterales en Bragpo y cuatro peldaños en contrachapado marino antideslizante marrón;
- 2 Escaleras de Madera compuesta por dos peldaños.

Complementos:

- 1 Par de Asideros en Bragpo;
- 2 Protectores corporales curvos en tubo Ø40mm de acero inox;
- 2 Protectores corporales rectos en tubo Ø40mm de acero inox;
- 1 Panel de protección con cuatro grabados en Bragpo;

Herrajes de acero eletrocincado.
Fijación al suelo Tipo X (atornillado).

Medidas generales (LxAnxA): 8608x4468x3247mm
Área de seguridad: 75m² | Área libre: 7467x12608mm
Edad recomendada de los usuarios: 0.5-12 años
Nº de usuarios: 25 niños

CARACTERÍSTICAS TÉCNICAS



POSTE MADERA

Perfil tipo trébol de 90x90mm con cuatro frisos de pino laminado, con tratamiento en autoclave y acabado en pintura al agua, color cerezo, especialmente desarrollado para proteger la madera de la humedad, condiciones climáticas adversas, rayos U.V. y la aparición de hongos y mohos. Tapas en BragPO atornilladas.
Garantía: 10 años.

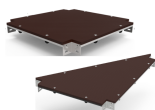

PLATAFORMAS EN CONTRACHAPADO MARINO

Laminado colado con resinas fenólicas a alta presión y temperatura, resistente a las condiciones climáticas adversas y rayos UV, según normas EL 314-2/clase 3 (DIN 68 TS TCIL3: BFU 100, BS 6566 PART 8: WBP); antideslizante y de bajo mantenimiento.
Reforzado con una estructura metálica galvanizada, proporcionando una alta resistencia mecánica, así como elementos corrosivos.
Garantía: 5 años



HERRAJES EN ACERO ELECTROCHAPADO

Herrajes en acero electrochapado, protegidos por cápsulas en polipropileno PP.

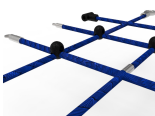

REDES Y COMPONENTES DE FIJACIÓN

Cuerdas reforzadas de acero galvanizado en caliente recubiertas por fibras de polipropileno con tratamiento térmico de inducción para reforzar la unión entre la cuerda y el acero, aumentando significativamente su resistencia. Accesorios de fijación de plástico BragPO HDPE con protección U.V., elementos de fijación de acero galvanizado en caliente.
Garantía: 5 años

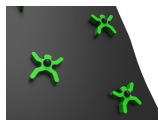

**ROCÓDROMO ESCALADA (DUMMY)**

Fabricados en polietileno de alta densidad monocolor o bicolor, sin HPA. Es un polímero de extrema ligereza y elasticidad caracterizado por resistencia a productos químicos, corrosión, rayos UV (UNE EN ISO 4892), alta resistencia a la inflamabilidad (UNE-EN ISO 11925-2) y resistencia al impacto (ISO 527-1). Imposibilita el cultivo tanto de bacterias como de hongos. No necesita ningún tipo de mantenimiento.

**PROTECTORES CORPORALES**

Fabricado en tubo de acero inoxidable AISI 304 Ø40mm, de acuerdo con la norma EN 14301, con acabado 2B. Garantía: 15 años.

**PUENTE INDIOS COLGANTE**

Puente en red fabricado con cuerdas Ø16mm reforzadas en acero recubierto por fibras de polipropileno, accesorios de unión y fijación en plástico brago con protección U.V., elementos de fijación en acero galvanizado en caliente y pasamanos en tubo 50mm en acero inoxidable AISI 304, de acuerdo con la norma EN 14301, con acabado 2B. Garantía: 15 años.

**ESCALERA HOJA**

Escaleras constituidas con laterales en brago: polietileno de alta densidad monocolor o bicolor. Por ser un polímero se caracteriza por su resistencia a los productos químicos y a la corrosión. Por su capacidad de elasticidad y ligereza, ofrece alta resistencia al impacto, siendo muy difícil su ruptura. La superficie antideslizante proporciona seguridad a los niños y su base sintética impide el cultivo de bacterias y hongos. No requiere ningún mantenimiento y cuatro peldaños en contrachapado marino antideslizante marrón y pegado con resinas fenólicas resistentes a la intemperie y los rayos UV. de conformidad con las normas EL 314-2/clase 3 (DIN 68 TS TCIL3: BFU 100, BS 6566 PART 8 : WBP).

**SISTEMA DE FIJACIÓN**

Tipo X - Sistema de fijación compuesto por una base metálica y atornillada al suelo rígido.

La base metálica es fabricada en chapa de acero al carbono, con tratamiento anticorrosivo de galvanización por inmersión en caliente con espesor entre 120 y 140µm de acuerdo con la norma EN ISO 1461, que permite su colocación sin que la viga entre en contacto directo con el suelo. Su fijación a la viga es hecha por un sistema de sujeción rápido aumentando la longevidad de la viga y su fácil y rápida sustitución en caso de necesidad.



FUNCIONES DE JUEGO



DIVERSIÓN

Mientras se divierten, los niños desarrollan una gran diversidad de capacidades, tales como: habilidades físicas, emocionales, sociales y motrices.



SOCIALIZAR

La importancia del juego reside en que éste, promueve la interacción social, despertando en los niños la necesidad de convivencia y solidaridad. Mientras juegan, los niños aprenden a compartir, respetar y escuchar a los demás niños. Es la mejor forma de iniciar su preparación para convivir en sociedad.



DESLIZARSE

Una superficie inclinada permite que el niño se deslice a cierta velocidad, aumentando, de esta manera, la liberación de su adrenalina. Esta sensación despierta nuevas emociones, permitiendo controlar los movimientos, ejercitando los reflejos y las habilidades motoras. Este movimiento permite a los niños controlar su comportamiento en ciertas situaciones de incomodidad emocional y/o física.



TREPAR

Desarrolla la coordinación motora de los niños, el control de su propio cuerpo, el equilibrio y resistencia. Esta actividad ayuda al niño a coordinar los movimientos de manos y pies con el apoyo de su percepción visual y cognitiva.



CONSTRUIR

Algunos juegos están especialmente desarrollados para que los niños afronten retos que les obliguen a pensar y a construir una solución productiva que les ayude a enfrentar cualquier tipo de problema, ya sea a nivel emocional o a nivel social.



SALTAR

Ejercicios que estimulan el acto del salto son extremadamente beneficiosos para la salud de los niños. Saltar estimula el aumento de masa y resistencia muscular.



EQUILIBRIO

El dominio de las habilidades motoras es básico para el desarrollo motor de los niños, ya que de esta forma el niño ejercita y desarrolla su equilibrio.



ESTIMULACIÓN VISUAL

A través de la estimulación visual, los niños adquieren incentivos esenciales que van a aumentar el desarrollo de su campo visual. De esta manera, es primordial que ellos desarrollen una visión funcional que les permita jugar y socializar para interiorizar informaciones del medio que los rodea, así como a desarrollar capacidades.



MEMORIA

Jugar, además de todos los beneficios, tanto lúdicos como físicos, que conllevan a un buen estado de salud de los niños, estimula también la memoria, ya que ésta, desempeña un papel fundamental en su desarrollo cognitivo, social y emocional.



ESTIMULACIÓN TÁCTIL

A través del acto del juego se consigue estimular el sentido táctil de una forma fácil y simple. La introducción de objetos con diferentes texturas permite que los niños comiencen a utilizar las manos, y de esta forma, se despierta su percepción sensorial táctil.



**CREATIVIDAD**

Se trata de acciones tales como inventar, soñar, pensar y percibir, que desarrollan la creatividad de los niños. De esta manera pasan a comprender y a usar sus competencias orales, motoras y cognitivas en las más diversas actividades.

**DESARROLLO COGNITIVO**

Un aspecto importante del simple acto de jugar es el desarrollo del raciocinio, de su imaginación y atención. Son esenciales nuevas diversiones, a través del juego, para estimular la capacidad de pensar, comprender y reaccionar, desarrollando así, el sistema cognitivo.

NORMAS**EN 1176-1**

Equipamiento de las áreas de juego y superficies
Parte 1: Requisitos generales de seguridad y métodos de ensayo.

**EN 1176-3**

Equipamiento de las áreas de juego y superficies
Parte 3: Requisitos de seguridad y métodos de ensayo adicionales específicos para toboganes

CONFIDENCIALIDAD Y PROPIEDAD INTELECTUAL

La información contenida en este documento es estrictamente confidencial, no pudiendo el destinatario reproducirla o permitir a terceros que la adquieran, utilicen o divulguen sin la previa y expresa autorización de BRICANTEL.

Todos los derechos de propiedad intelectual sobre los diseños y modelos presentados son de titularidad exclusiva de BRICANTEL, estando expresamente prohibida la práctica de cualquier acto de usurpación de los mismos sin el previo consentimiento de la empresa, dentro de los términos del código de propiedad industrial y del código de derechos de autor y derechos análogos. La violación de la obligación de confidencialidad y/o de los derechos de propiedad intelectual de BRICANTEL, puede dar origen a responsabilidad civil y criminal.



DESCRIPTION

BragPLAY equipment, Danaus Park ABIBE (FFH-2.00m), composed of:



-2 Cloud tower with a tree in BragPO (FFH-0.90m), wood posts of 90x90mm in cherry tree color, and platforms with galvanized structure coated in Brown anti-slip marine plywood;
-1 Simple mini tower (FFH-1.30m), wood posts of 90x90mm in cherry tree color and plataformas with galvanized structure coated in Brown anti-slip marine plywood.

Links:

-1 Suspension mining bridge (FFH-1.30m) with four steps in BragPO, made of steel reinforced ropes coated with Ø16mm polypropylene fibers and Ø50mm stainless steel upper support in a tube;
-1 Vertical net (FFH-1.10m), in a rope web reinforced in steel coated by polypropylene fibers Ø16mm with upper support in stainless steel tube Ø50mm;
-1 Vertical net (FFH-2.00m), in a rope web reinforced in steel coated by polypropylene fibers Ø16mm with upper support in stainless steel tube Ø50mm.

Access ways:

-1 Danaus climbing ramp (FFH-0.90m), in Brown anti-slip marine plywood with six Dummy climbing stones in BragPO;
-1 Savana slide (FFH-1.30m) in rotomolded BragPO with a guard panel in BragPO;
-1 Savana slide (FFH-0.90m) in rotomolded BragPO with a guard panel in BragPO; -1 Leaf ladder (FFH-0.90m) with BragPO sides, with four steps in Brown anti-slip marine plywood;
-2 Ladders in BragPO with two steps.

Add-on:

-1 Pair of handles in BragPO;
-2 curved guardrails in stainless steel Ø40mm tube;
-2 straight guardrails in stainless steel Ø40mm tube;
-1 protective barrier panel with four slats in Bragpo.

Hardware in electro-zinc steel.

Ground fixing type X (screw).

General measures (LxWxH): 8608x4468x3247mm

Security area: 75m² | Free area: 7467x12608mm

Age range: 0.5-12 years old

Number of users: 25

TECHNICAL FEATURES



WOOD BEAM

90x90mm clover type profile with four laminated pine friezes, with autoclave treatment and final finish in water-based paint, with cherry color, specially developed to protect the wood from humidity, weather, U.V. rays and the appearance of fungi and molds. BragPO cover fixed.
Guarantee: 10 years.

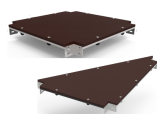

PLATFORM IN MARINE PLYWOOD

Glued laminate with phenolic resins at high pressure and temperature, resistant to the weather and UV rays, according to EL 314-2/class 3 standards (DIN 68 TS TCIL3: BFU 100, BS 6566 PART 8: WBP) non-slip and low maintenance. Reinforced with a galvanized metallic structure, providing a high mechanical resistance as well as resistance to corrosive elements.
Guarantee: 5 years



STEEL ELECTROPLATED HARDWARE

Steel electroplated hardware, protected by polypropylene PP capsules.

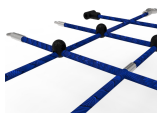

NETS AND ATTACHMENT COMPONENTS

Ø16/18mm cords reinforced with hot galvanized steel coated with polypropylene fibers with induction heat treatment to strengthen the bond between the rope and the steel, significantly increasing its strength. Attachment accessories and fastening in plastic Bragpo HDPE with protection U.V., hot galvanized steel fasteners.
Warranty: 5 years old

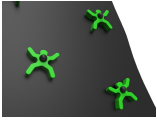

**ROCK CLIMBING (DUMMY)**

Made of high density in one color or bicolor polyethylene, free of HPA. It is a polymer of extreme lightness and elasticity characterized by resistance to chemicals, corrosion, UV rays (UNE EN ISO 4892), high flammability resistance (UNE-EN ISO 11925-2) and impact resistance (ISO 527-1). It makes it impossible to grow both bacteria and fungi.

**BODYGUARD**

Made of stainless steel AISI 304 tube Ø40mm, according to EN 14301, with 2B finish.
Guarantee: 15 years.

**BRIDGE INDIANA SUSPENS**

Networked bridge made of Ø16mm cords reinforced in steel coated with polypropylene fibres, fittings for connecting and attaching in braggo plastic with U.V.protection, hot galvanised steel fasteners and tube handrails Ø50mm in AISI 304 stainless steel, according to EN 14301, with 2B finish.
Guarantee: 15 years.

**STAIRCASE FOLHA**

Staircases with sides in braggo: polyethylene of high density monocolour or bicolor. Being a polymer is characterized by its resistance to chemicals and corrosion. Due to its elasticity and lightness, it offers high resistance to impact, being very difficult to break. The non-slip surface provides safety for children and its synthetic base prevents the cultivation of bacteria and fungus. It does not require any maintenance and four steps in marine plywood anti-slip brown and glued with phenolic resins resistant to weathering and UV rays. In accordance with EL 314-2/Class 3 (DIN 68 TS TCIL3: BFU 100, BS 6566 PART 8 : WBP).

**FIXATION SYSTEM**

Type X - Fixation system composed of a metal base bolted to the hard ground.

The metal base is made of carbon steel sheet, with corrosion-resistant hot-dip galvanisation treatment of between 120 and 140µm thickness according to EN ISO 1461, which allows its placement without the plumb in direct contact with the ground. Its attachment to the plumb line is made by a quick clamping system increasing the longevity of the plumb line and its easy and fast replacement in case of need.



PLAY FUNCTIONS**FUN**

While having fun, children acquire immense abilities, from physical abilities to social interactions.

**SOCIALIZING**

Socialization and imagination are necessary throughout the game. All this creates a relationship between children and awakens the sense of coexistence and solidarity.

**SLIDE**

The inclined surface allows the child to slide at great speed, increasing his adrenaline. This sensation awakens new emotions, allowing to control movements exercising reflexes and motor skills. This movement helps the child to control their behavior in situations of emotional and/or physical discomfort.

**CLIMB**

It develops the children's motor coordination, control of their own body, balance and resistance. This activity helps the child to coordinate the movements of the hands and feet with the help of their visual and cognitive perception.

**BUILD**

Some games are developed so that children face challenges that force them to think and build a beneficial solution that helps them face the problem, emotionally or socially.

**JUMP**

Exercises that stimulate the act of jumping are extremely beneficial for the health of children. Jumping stimulates increased muscle mass and endurance.

**EQUILIBRIUM**

The mastery of motor skills is basic for the child's motor development, so it's important for the child to train and develop their balance.

**VISUAL STIMULATION**

It's through visual stimulation that children acquire essential stimuli that will boost the development of their visual field. Thus, it's essential that they develop a functional vision that allows them to play, socialize to internalize information from their surroundings and develop skills.

**MEMORY**

Play, in addition to all the physical benefits it gives to children's health, also stimulates memory, which plays a key role in cognitive, social and development.

**TACTILE STIMULATION**

It's through the act of play that it's possible to stimulate the tactile system in an easy and simple way, the introduction of objects with different textures allows children to start using their hands and thus awaken their tactile sensory perception.



**CREATIVITY**

These are actions such as inventing, dreaming, thinking and experimenting, which develop children's creativity. In this way, they begin to understand and use their oral, motor and cognitive skills in the most diverse activities.

**COGNITIVE DEVELOPMENT**

An important aspect of play is the development of reasoning, imagination and attention. New games are essential to stimulate the ability to think, understand and act, developing the cognitive system.

STANDARTS

EN 1176-1
Playground equipment and surfacing
Part 1: General safety requirements and test methods



EN 1176-3
Playground equipment and surfacing
Part 3: Additional specific safety requirements and test methods for slides

CONFIDENTIALITY AND INTELLECTUAL PROPERTY

The information contained in this document is confidential, and the recipient cannot reproduce it or allow third parties to obtain, use or disclose it without the prior and express authorization of BRICANTEL. All intellectual property rights over the designs and models presented are the exclusive property of BRICANTEL, and the practice of any act of exploitation thereof without the consent of the latter, under the terms of the industrial property code and the copyright code and related rights. Violation of BRICANTEL's obligation of confidentiality and / or intellectual property rights may give rise to civil and criminal liability.



DESCRIPTION

Équipement BragPLAY, Danaus Park ABIBE (NQA - 2.00m), composé de :



- 2 Cloud Towers avec Braggo Tree (AQL - 0,90m), montants et plates-formes en merisier 90x90mm avec structure galvanisée recouverte de contreplaqué marine antidérapant marron;
- 1 Mini Tours simples (NQA - 1,30m), étais et plates-formes en merisier 90x90mm avec structure galvanisée recouverte de contreplaqué marine antidérapant marron;

Connexions:

- 1 pont suspendu Minas (NQA - 1,30m) à quatre marches à Braggo, réalisé avec des câbles en acier renforcés revêtus de fibres de polypropylène Ø16mm et mains courantes en tube inox Ø50mm;
- 1 Hamac vertical (NQA - 2,00m) en toile de corde renforcée acier enduite de fibres polypropylène Ø16mm avec support supérieur en tube inox Ø50mm;
- 1 Hamac vertical (NQA - 1,10m) en toile de corde renforcée acier enduite de fibres polypropylène Ø16mm avec support supérieur en tube inox Ø50mm.

Moyens d'accès;

- 1 rampe d'escalade Danaus (NQA - 0,90m) en contreplaqué marin anti-dérapant marron avec six pierres factices à Braggo;
- 1 Toboggan Savana (NQA - 1,30m) en Braggo Rotomoulé avec panneau de garde Braggo;
- 1 Toboggan Savana (NQA - 0,90m) en Braggo rotomoulé avec panneau de garde Braggo;
- Échelle à 1 vantail (NQA - 0,90m) avec côtés Braggo et quatre marches en contreplaqué marine antidérapant marron;
- 2 escabeaux en bois à deux marches.

Suppléments;

- 1 paire de poignées Braggo;
- 2 garde-corps courbes en tube inox Ø40mm;
- 2 garde-corps droits en tube inox Ø40mm;
- 1 panneau barrière de protection avec quatre trous à Braggo.

Quincaillerie en acier électrozingué.

Fixation au sol type X (vissage).

Dimensions globales (Lxlxh) : 8608x4468x3247mm

Zone de sécurité : 75m² | Zone libre : 7467x12608mm

Tranche d'âge : 0,5 à 12 ans

Nombre d'utilisateurs : 25

CARACTÉRISTIQUES TECHNIQUES



POUTRE BOIS

Au profil type tréfle de 90x90mm avec quatre frises en pin laminé, avec traitement autoclave et finition à la peinture à l'eau, couleur cerise, spécialement développée pour protéger le bois de l'humidité, des intempéries, des rayons U.V. et de l'apparition de champignons et moisissures. Embout en BragPO fixés.
Garantie: 10 ans.

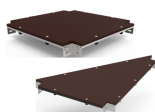

PLATEFORMES EN CONTRE-PLAQUÉ MARIN

Stratifié et collé avec des résines phénoliques à haute pression et température, résistant aux intempéries et aux rayons UV, selon les normes EL 314-2/classe 3 (DIN 68 TS TCIL3: BFU 100, BS 6566 PART 8: WBP). Antidérapant et peu d'entretien.

Renforcé avec une structure métallique galvanisée, offrant une résistance mécanique élevée ainsi qu'une résistance aux éléments corrosifs.

Garantie: 5 ans



FERRURES EN ACIER ELECTROZINGÉ

Ferrures en acier electrozingué, protégé para des capsules en polypropylène PP.

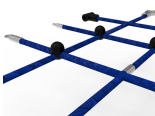

FILETS ET COMPOSANTS DE FIXATION

Cordes Ø16/18mm renforcées en acier galvanisé à chaud recouvert de fibres de polypropylène avec traitement thermique à induction pour renforcer le lien entre la corde et l'acier, augmentant de manière significative sa résistance. Accessoires de fixation en plastique Braggo HDPE avec protection U.V., éléments de fixation en acier galvanisé à chaud.

Garantie : 5 ans

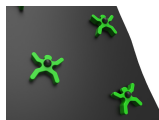

**PIERRES D'ESCALADE (DUMMY)**

Fabriqués en polyéthylène de haute densité monocolore ou bicolore, sans HPA. C'est un polymère extrêmement léger et élastique caractérisé par sa résistance aux produits chimiques, à la corrosion, aux rayons UV (UNE EN ISO 4892), sa haute résistance à l'inflammabilité (UNE-EN ISO 11925-2) et sa résistance aux chocs (ISO 527-1). Ne nécessite aucun entretien.

**GARDE CORPS**

Fabriqués en tube d'acier inoxydable AISI 304 Ø40mm, selon la norme EN 14301, finition 2B.
Garantie : 15 ans.

**PONT INDIANA SUSPENDU**

Pont en filet fabriqué avec des cordes Ø 16mm renforcées en acier revêtu de fibres de polypropylène, accessoires de fixation et de fixation en plastique braguette avec protection U.V., éléments de fixation en acier galvanisé à chaud et mains courantes à tube Ø50mm en acier inoxydable AISI 304, selon la norme EN 14301, avec une finition 2B.
Garantie: 15 ans.

**ESCALIER FOLHA**

Escaliers constitués de côtés en braggo : polyéthylène de haute densité monocolore ou bicolore. En tant que polymère, il se caractérise par sa résistance aux produits chimiques et à la corrosion. Par sa capacité d'élasticité et de légèreté, il offre une résistance élevée à l'impact et est très difficile à briser. La surface antidérapante fournit une sécurité pour les enfants et sa base synthétique empêche la culture de bactéries et champignons. Il ne nécessite aucun entretien et quatre marches en contreplaqué maritime antidérapant brun et collé avec des résines phénoliques résistant aux intempéries et aux rayons UV. conformément aux normes EL 314-2/classe 3 (DIN 68 TS TCIL3 : BFU 100, BS 6566 PART 8 : WBP).

**SISTÈME DE FIXATION**

Type X - Système de fixation composé d'une base métallique fixée au sol rigide.

La base métallique est fabriquée en tôle d'acier carbone, avec un traitement anticorrosion par galvanisation par immersion à chaud d'une épaisseur comprise entre 120 et 140µm selon la norme EN ISO 1461, qui permet sa pose sans que la poutre rentre en contact direct avec le sol. Sa fixation à la poutre est réalisée par un système de serrage rapide augmentant sa longévité et facilitant son remplacement, qui sera rapide en cas de besoin.



FUNCIONES LUDICAS**AMUSEMENT**

En s'amusant, les enfants développent plusieurs capacités telles que des habilités physiques, émotionnelles, sociales et motrices.

**SOCIALES**

L'importance de jouer se note dans l'interaction sociale que nécessitent ces activités, réveillant en eux le sens de la convivialité et de la solidarité. En jouant, les enfants apprennent à partager, respecter, et écouter autrui. De cette manière, ils débutent leur apprentissage en vie de société.

**GLISSER**

L'inclinaison du toboggan permet aux enfants de glisser à grande vitesse, augmentant ainsi son adrénaline. Cette sensation réveille de nouvelles émotions permettant de contrôler les mouvements, entraînant ainsi les réflexes et les capacités motrices. Cette action aide l'enfant à contrôler son comportement lors de situation inconfortable, quelle soit émotionnelle ou physique.

**GRIMPER**

Escalader aide à développer la coordination des enfants, le contrôle de leurs corps, l'équilibre et la résistance. Cette activité aide à allier le mouvement de ses mains et de ses pieds en s'aidant de sa perception visuelle et cognitive.

**CONSTRUIRE**

Certains jeux sont créés pour que les enfants se retrouvent face à des défis qui les obligent à réfléchir et construire de manière logique une solution bénéfique qui les aidera à faire face au problème apparent, qu'il soit affectif ou social.

**SAUTER**

Les exercices nécessitant faire appel aux sauts sont excellent pour la santé de l'enfant. Cette action stimule la résistance et la masse musculaire.

**ÉQUILIBRE**

Dominer sa motricité est la base pour accroître la croissance de l'enfant, c'est pour cela qu'il est important que les jeunes entraînent leur équilibre.

**STIMULATION VISUELLE**

C'est au travers de cette action que les enfants vont comprendre le fonctionnement de plusieurs activités, c'est pour cela qu'il est important qu'ils développent leur perception visuelle et leur champ de vision. Grâce à ses capacités, ils pourront assimiler plus facilement des informations qui les entourent et développer plus facilement certaines capacités.

**MÉMOIRE**

Jouer apporte énormément aux enfants d'un point de vue physique, mais aussi au niveau psychique. En effet, jouer développe la mémoire des enfants au niveau cognitif, social et émotionnel.

**STIMULATION TACTILE**

Certains jeux sont tactiles. En effet, en faisant appel à différentes formes et matières pour lesquelles l'enfant utilise ses mains afin de trouver une solution.



**CRÉATIVITÉ**

Rêver, inventer, penser et essayer, se sont là des actes qui aident les enfants à développer leur créativité. De cette manière, ces derniers comprennent comment utiliser leur compétence orale, motrice et cognitive dans de diverses situations.

**DÉVELOPPEMENT COGNITIF**

Un aspect importante lors de la diversion des enfants, c'est le développement de leurs sens, imagination et attention. De nouveaux jeux sont essentiels pour stimuler leurs capacités à penser, comprendre et agir.

NORMES**EN 1176-1**

Équipements et sols d'aires de jeux

Partie 1: Exigences de sécurité et méthodes d'essai générales

**EN 1176-3**

Équipement et sols d'aires de jeux

Partie 3: Exigences de sécurité et méthodes d'essai complémentaires spécifiques aux toboggans

CONFIDENTIALITÉ ET PROPRIÉTÉ INTELLECTUELLE

Les informations contenues dans ce document sont confidentielles et le destinataire ne peut pas les reproduire ni permettre à des tiers de les obtenir, de les utiliser ou de les divulguer sans l'autorisation préalable et expresse de BRICANTEL.

Tous les droits de propriété intellectuelle sur les dessins et modèles présentés sont propriété exclusive de BRICANTEL, et la pratique d'un acte d'exploitation de ceux-ci sans le consentement de cette dernière, selon les termes du code de la propriété industrielle et du code du droit d'auteur et des droits voisins. La violation de l'obligation de confidentialité et / ou des droits de propriété intellectuelle de BRICANTEL peut engager à la responsabilité civile et pénale.

