

Tolerância Geral: ± 5%



12,00 m²



0,00 m



3-14



2

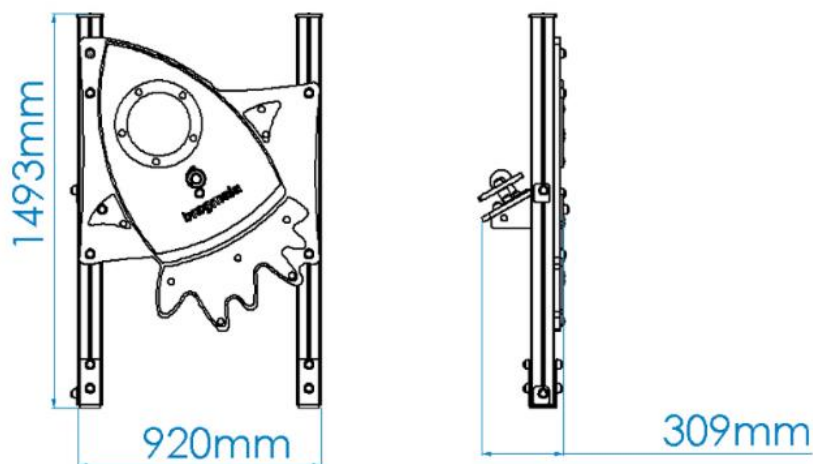
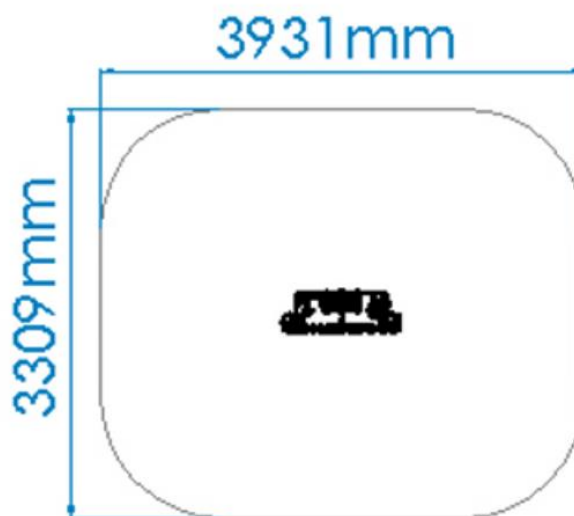

MEDIDAS GERAIS / MEDIDAS GENERALES / GENERAL MEASURES / MESURES GÉNÉRALES

INSTALAÇÃO / INSTALACIÓN / INSTALLATION / INSTALLATION

0,20m³



01:30h



3x



15,00kg



36,00kg



Parques Infantis
Playground

Parques Infantiles
Aires de Jeux

Informação sujeita a alterações sem aviso prévio.

ESPAÑA
www.bricantel.com
info@bricantel.com

PORTUGAL
www.bricantel.pt
info@bricantel.pt



@bricantel
bricantelpt
@bricantel

Data de exportação: 30/11/2023



DESCRIÇÃO

Equipamento BragPLAY, O Foguetão, acessível a crianças com mobilidade reduzida composto por 2 prumos 90x90 em madeira, com painel de jogo em Bragpo.
Ferragens em aço eletrozincado.
Fixação ao solo tipo Y (chumbar).

Medidas gerais (CxLxA): 920x309x1493mm
Área de segurança: 12m² | Área livre: 3309x3931mm
Faixa etária: 3-14 anos
Nº de utilizadores: 2

CARACTERÍSTICAS TÉCNICAS



PRUMO MADEIRA

Perfil tipo trevo de 90x90mm com quatro frisos em pinho laminado, com tratamento autoclave e acabamento final a tinta de base aquosa, com cor cerejeira, especialmente desenvolvida para proteger a madeira de humidades, intempéries, raios U.V. e aparecimento de fungos e bolores; Tacos em BragPO aparafusados.
Garantia: 10 anos

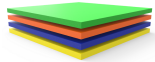

BRAGPO

BragPO HDPE de alta densidade monocolor ou bicolor, livre de HPA. Caracterizado pela sua extrema leveza e elasticidade, resistência a produtos químicos, corrosão, raios UV (UNE EN ISO 4892), alta resistência à inflamabilidade (UNE-EN ISO 11925-2) e resistência a impactos (ISO 527-1). Não necessita de qualquer manutenção.
Garantia: 15 anos



FERRAGENS EM AÇO ELETROZINCADO

Ferragens em aço eletrozincado, protegidas por cápsulas em polipropileno PP.



SISTEMA DE FIXAÇÃO

Tipo Y - Sistema de fixação composto por base metálica embutida ou por prumos aplicado diretamente no solo e chumbada com betão.

A base metálica embutida é fabricada em chapa de aço carbono, com tratamento anticorrosivo de galvanização por imersão a quente com espessura entre 120 a 140µm de acordo com a norma EN ISO 1461, que permite a sua colocação sem que o prumo entre em contacto direto com o solo. A sua fixação ao prumo é feita por um sistema de aperto rápido aumentando a longevidade do prumo e a sua fácil e rápida substituição em caso de necessidade.



FUNÇÕES LÚDICAS



DIVERSÃO

Enquanto se divertem, as crianças desenvolvem imensas capacidades, tais como: habilidades físicas, emocionais, sociais e motoras.



SOCIALIZAR

A importância de brincar reside no facto das brincadeiras promoverem a interação social, despertando-lhes o senso de convivência e solidariedade. Enquanto brincam, as crianças aprendem a partilhar, respeitar e ouvir os outros, desta forma iniciam a sua preparação para viver em sociedade.



ESTIMULAÇÃO VISUAL

É através da estimulação visual, que as crianças adquirem estímulos essenciais que vão impulsionar o desenvolvimento do seu campo visual. Assim, é essencial que estas desenvolvam uma visão funcional, que as permita brincar, socializar para interiorizar informações do meio que as rodeia e desenvolver competências.



MEMÓRIA

Brincar, para além de todos os benefícios físicos que confere à saúde das crianças, estimula também a memória, sendo que esta desempenha um papel fundamental no desenvolvimento cognitivo, social e emocional.



ESTIMULAÇÃO TÁTIL

É através do ato de brincar que se consegue estimular o sistema tátil de uma forma fácil e simples, a introdução de objetos com diferentes texturas permite que as crianças comecem a utilizar as mãos e desta forma, despertar a sua perceção sensorial tátil.



CRIATIVIDADE

São ações como inventar, sonhar, pensar e experimentar, que desenvolvem a criatividade das crianças. Dessa forma, estas passam a compreender e a usar as suas competências orais, motoras e cognitivas nas mais diversas atividades.



DESENVOLVIMENTO COGNITIVO

Um aspeto importante do ato de brincar, é o desenvolvimento do raciocínio, da sua imaginação e atenção. Novas brincadeiras são essenciais para estimular a capacidade de pensar, compreender e agir, desenvolvendo o sistema cognitivo.

NORMAS



EN 1176-1

Equipamentos e superfícies para espaços de jogo e recreio
Parte 1: Requisitos de segurança e métodos de ensaio gerais

CONFIDENCIALIDADE E PROPRIEDADE INTELECTUAL

A informação contida neste documento é confidencial, não podendo o destinatário do mesmo reproduzi-la ou permitir a terceiros que a obtenham, utilizem ou divulguem sem a prévia e expressa autorização da BRICANTEL.

Todos os direitos de propriedade intelectual sobre os desenhos e modelos apresentados são da titularidade exclusiva da BRICANTEL, sendo expressamente proibida a prática de qualquer ato de exploração dos mesmos sem o consentimento desta, nos termos do código da propriedade industrial e do código do direito de autor e dos direitos conexos. A violação da obrigação de confidencialidade e/ou dos direitos de propriedade intelectual da BRICANTEL, pode dar origem a responsabilidade civil e criminal.



Parques Infantis
Playground

Parques Infantiles
Aires de Jeux

Informação sujeita a alterações sem aviso prévio.

ESPAÑA
www.bricantel.com
info@bricantel.com

PORTUGAL
www.bricantel.pt
info@bricantel.pt



@bricantel
bricantelpt
@bricantel

Data de exportação: 30/11/2023



DESCRIPCIÓN

Equipamiento BragPLAY, "COHETE", accesible a niños con movilidad reducida; compuesto por 2 postes de 90x90 en madera y panel de juego en Bragpo.

Herrajes de acero electrocincado.

Fijación al suelo Tipo Y (hormigonado).

Medidas generales (LxAnxA): 920x309x1493mm

Área de seguridad: 12m² | Área libre: 3309x3931mm

Rango de edad: 3-14 años

Nº de usuarios: 2 niños

CARACTERÍSTICAS TÉCNICAS



POSTE MADERA

Perfil tipo trébol de 90x90mm con cuatro frisos de pino laminado, con tratamiento en autoclave y acabado en pintura al agua, color cerezo, especialmente desarrollado para proteger la madera de la humedad, condiciones climáticas adversas, rayos U.V. y la aparición de hongos y mohos. Tapas en BragPO atornilladas.

Garantía: 10 años.

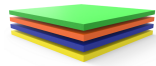

BRAGPO

BragPO HDPE de alta densidad monocolor o bicolor, sin HPA. Caracterizado por su extrema ligereza y elasticidad, resistencia a productos químicos, corrosión, rayos UV (UNE EN ISO 4892), a la inflamabilidad (UNE-EN ISO 11925-2) y al impacto (ISO 527-1). No necesita ningún tipo de mantenimiento.

Garantía: 15 años



HERRAJES EN ACERO ELECTROCHAPADO

Herrajes en acero electrochapado, protegidos por cápsulas en polipropileno PP.



SISTEMA DE FIJACIÓN

Tipo Y - Sistema de fijación estándar compuesto por una base metálica o poste embutido al suelo y con relleno de hormigón.

La base metálica incorporada está fabricada en chapa de acero de carbono, con tratamiento anticorrosivo por inmersión en caliente de 120 a 140µm de espesor según EN ISO 1461, que permite su colocación sin que el poste entre en contacto directo con el suelo. Su fijación a al poste se realiza por un sistema de sujeción rápido aumentando la longevidad del poste y su fácil y rápida sustitución en caso de necesidad.



Parques Infantis
Playground

Parques Infantiles
Aires de Jeux

Informação sujeita a alterações sem aviso prévio.

ESPAÑA
www.bricantel.com
info@bricantel.com

PORTUGAL
www.bricantel.pt
info@bricantel.pt



@bricantel
bricantelpt
@bricantel

Data de exportação: 30/11/2023

FUNCIONES DE JUEGO



DIVERSIÓN

Mientras se divierten, los niños desarrollan una gran diversidad de capacidades, tales como: habilidades físicas, emocionales, sociales y motrices.



SOCIALIZAR

La importancia del juego reside en que éste, promueve la interacción social, despertando en los niños la necesidad de convivencia y solidaridad. Mientras juegan, los niños aprenden a compartir, respetar y escuchar a los demás niños. Es la mejor forma de iniciar su preparación para convivir en sociedad.



ESTIMULACIÓN VISUAL

A través de la estimulación visual, los niños adquieren incentivos esenciales que van a aumentar el desarrollo de su campo visual. De esta manera, es primordial que ellos desarrollen una visión funcional que les permita jugar y socializar para interiorizar informaciones del medio que los rodea, así como a desarrollar capacidades.



MEMORIA

Jugar, además de todos los beneficios, tanto lúdicos como físicos, que conllevan a un buen estado de salud de los niños, estimula también la memoria, ya que ésta, desempeña un papel fundamental en su desarrollo cognitivo, social y emocional.



ESTIMULACIÓN TÁCTIL

A través del acto del juego se consigue estimular el sentido táctil de una forma fácil y simple. La introducción de objetos con diferentes texturas permite que los niños comiencen a utilizar las manos, y de esta forma, se despierte su percepción sensorial táctil.



CREATIVIDAD

Se trata de acciones tales como inventar, soñar, pensar y percibir, que desarrollan la creatividad de los niños. De esta manera pasan a comprender y a usar sus competencias orales, motoras y cognitivas en las más diversas actividades.



DESARROLLO COGNITIVO

Un aspecto importante del simple acto de jugar es el desarrollo del raciocinio, de su imaginación y atención. Son esenciales nuevas diversiones, a través del juego, para estimular la capacidad de pensar, comprender y reaccionar, desarrollando así, el sistema cognitivo.

NORMAS



EN 1176-1

Equipamiento de las áreas de juego y superficies
Parte 1: Requisitos generales de seguridad y métodos de ensayo.

CONFIDENCIALIDAD Y PROPIEDAD INTELECTUAL

La información contenida en este documento es estrictamente confidencial, no pudiendo el destinatario reproducirla o permitir a terceros que la adquieran, utilicen o divulguen sin la previa y expresa autorización de BRICANTEL.

Todos los derechos de propiedad intelectual sobre los diseños y modelos presentados son de titularidad exclusiva de BRICANTEL, estando expresamente prohibida la práctica de cualquier acto de usurpación de los mismos sin el previo consentimiento de la empresa, dentro de los términos del código de propiedad industrial y del código de derechos de autor y derechos análogos. La violación de la obligación de confidencialidad y/o de los derechos de propiedad intelectual de BRICANTEL, puede dar origen a responsabilidad civil y criminal.



Parques Infantis
Playground

Parques Infantiles
Aires de Jeux

ESPAÑA
www.bricantel.com
info@bricantel.com

PORTUGAL
www.bricantel.pt
info@bricantel.pt



@bricantel
bricantelpt
@bricantel

Data de exportação: 30/11/2023

Informação sujeita a alterações sem aviso prévio.



DESCRIPTION

BragPLAY equipment, The Rocket, accessible to children with reduced mobility, consisting of two 90x90 wooden props, with a Bragpo play panel.

Electro-zinc-plated steel fittings.
Y-type ground fixing (in-ground).

Dimensions (LxWxH): 920x309x1493mm
Safety area: 12m² | Free area: 3309x3931mm
Age range: 3-14 years
Number of users: 2

TECHNICAL FEATURES



WOOD BEAM

90x90mm clover type profile with four laminated pine friezes, with autoclave treatment and final finish in water-based paint, with cherry color, specially developed to protect the wood from humidity, weather, U.V. rays and the appearance of fungi and molds. BragPO cover fixed.
Guarantee: 10 years.

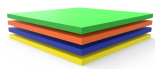

BRAGPO

BragPO HDPE of high density in one color or bicolor, free of HPA. Characterized by its extreme lightness and elasticity, resistance to chemicals, corrosion, UV rays (UNE EN ISO 4892), to flammability (UNE-EN ISO 11925-2) and impact (ISO 527-1). It doesn't need any maintenance.
Guarantee: 15 years.



STEEL ELECTROPLATED HARDWARE

Steel electroplated hardware, protected by polypropylene PP capsules.



FIXATION SYSTEM

Type Y - Fixation system composed of built-in metal base or plumbing applied directly to the ground and concrete sinker. The built-in metal base is made of carbon steel sheet, with corrosion-resistant hot-dip galvanisation treatment of between 120 and 140µm thickness according to EN ISO 1461, which allows its placement without the plumb in direct contact with the ground. Its attachment to the plumb line is made by a quick clamping system increasing the longevity of the plumb line and its easy and fast replacement in case of need.



PLAY FUNCTIONS



FUN

While having fun, children acquire immense abilities, from physical abilities to social interactions.



SOCIALIZING

Socialization and imagination are necessary throughout the game. All this creates a relationship between children and awakens the sense of coexistence and solidarity.



VISUAL STIMULATION

It's through visual stimulation that children acquire essential stimuli that will boost the development of their visual field. Thus, it's essential that they develop a functional vision that allows them to play, socialize to internalize information from their surroundings and develop skills.



MEMORY

Play, in addition to all the physical benefits it gives to children's health, also stimulates memory, which plays a key role in cognitive, social and development.



TACTILE STIMULATION

It's through the act of play that it's possible to stimulate the tactile system in an easy and simple way, the introduction of objects with different textures allows children to start using their hands and thus awaken their tactile sensory perception.



CREATIVITY

These are actions such as inventing, dreaming, thinking and experimenting, which develop children's creativity. In this way, they begin to understand and use their oral, motor and cognitive skills in the most diverse activities.



COGNITIVE DEVELOPMENT

An important aspect of play is the development of reasoning, imagination and attention. New games are essential to stimulate the ability to think, understand and act, developing the cognitive system.

STANDARTS



EN 1176-1

Playground equipment and surfacing
Part 1: General safety requirements and test methods

CONFIDENTIALITY AND INTELLECTUAL PROPERTY

The information contained in this document is confidential, and the recipient cannot reproduce it or allow third parties to obtain, use or disclose it without the prior and express authorization of BRICANTEL. All intellectual property rights over the designs and models presented are the exclusive property of BRICANTEL, and the practice of any act of exploitation thereof without the consent of the latter, under the terms of the industrial property code and the copyright code and related rights. Violation of BRICANTEL's obligation of confidentiality and / or intellectual property rights may give rise to civil and criminal liability.

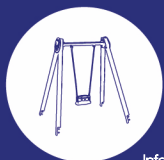

Parques Infantis
Playground

Parques Infantiles
Aires de Jeux

Informação sujeita a alterações sem aviso prévio.

ESPAÑA
www.bricantel.com
info@bricantel.com

PORTUGAL
www.bricantel.pt
info@bricantel.pt



@bricantel
bricantelpt
@bricantel

Data de exportação: 30/11/2023



DESCRIPTION

Équipement BragPLAY, La Fusée, accessible aux enfants à mobilité réduite, composé de 2 poteaux en bois 90 x 90 avec un panneau de jeu en Bragpo.

Visserie en acier électrozingué.

Fixation au sol de type Y (bétonner).

Dimensions (Lxlxh): 920x309x1493mm

Zone de sécurité: 12m2 | Zone libre: 3309x3931mm

Tranche d'âge: 3-14 ans

Nombre d'utilisateurs: 2

CARACTÉRISTIQUES TECHNIQUES



POUTRE BOIS

Au profil type trèfle de 90x90mm avec quatre frises en pin laminé, avec traitement autoclave et finition à la peinture à l'eau, couleur cerise, spécialement développée pour protéger le bois de l'humidité, des intempéries, des rayons U.V. et de l'apparition de champignons et moisissures. Embout en BragPO fixés.

Garantie: 10 ans.

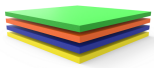

BRAGPO

BragPO HDPE d'une couleur ou bicolore de haute densité, sans HPA. Caractérisé par son extrême légèreté et élasticité, résistante aux produits chimiques, à la corrosion, aux rayons UV (UNE EN ISO 4892), à l'inflammabilité (UNE-EN ISO 11925-2) et aux impacts (ISO 527-1). Pas d'entretien nécessaire.

Garantie: 15 ans.



FERRURES EN ACIER ELECTROZINGÉ

Ferrures en acier électrozingué, protégé para des capsules en polypropylène PP.



SISTÈME DE FIXATION

Type Y - Système de fixation composé d'une base métallique encastrée ou d'une poutre appliquée directement au sol et bétonnée.

La base métallique encastrée est fabriquée en tôle d'acier carbone, avec un traitement anticorrosion par galvanisation par immersion à chaud d'une épaisseur comprise entre 120 et 140µm selon la norme EN ISO 1461, qui permet sa pose sans que la poutre rentre en contact direct avec le sol. Sa fixation à la poutre est réalisée par un système de serrage rapide augmentant sa longévité et facilitant son remplacement, qui sera rapide en cas de besoin.



FONCTIONS LUDIQUES



AMUSEMENT

En s'amusant, les enfants développent plusieurs capacités telles que des habilités physiques, émotionnelles, sociales et motrices.



SOCIALES

L'importance de jouer se note dans l'interaction sociale que nécessitent ces activités, réveillant en eux le sens de la convivialité et de la solidarité. En jouant, les enfants apprennent à partager, respecter, et écouter autrui. De cette manière, ils débentent leur apprentissage en vie de société.



STIMULATION VISUELLE

C'est au travers de cette action que les enfants vont comprendre le fonctionnement de plusieurs activités, c'est pour cela qu'il est important qu'ils développent leur perception visuelle et leur champ de vision. Grâce à ses capacités, ils pourront assimiler plus facilement des information qui les entourent et développer plus facilement certaines capacités.



MÉMOIRE

Jouer apporte énormément aux enfants d'un point de vue physique, mais aussi au niveau psychique. En effet, jouer développe la mémoire des enfants au niveau cognitif, social et émotionnelle.



STIMULATION TACTILE

Certains jeux sont tactiles. En effet, en faisant appel à différentes formes et matières pour lesquelles l'enfant utilise ses mains afin de trouver une solution.



CRÉATIVITÉ

Rêver, inventer, penser et essayer, se sont là des actes qui aident les enfants a développer leur créativité. De cette manière, ces derniers comprennent comment utiliser leur compétence orale, motrice et cognitive dans de diverses situations.



DÉVELOPPEMENT COGNITIF

Un aspect importante lors de la diversion des enfants, c'est le développement de leurs sens, imagination et attention. De nouveaux jeux sont essentiels pour stimuler leurs capacités à penser, comprendre et agir.

NORMES



EN 1176-1

Équipements et sols d'aires de jeux
Partie 1: Exigences de sécurité et méthodes d'essai générales

CONFIDENTIALITÉ ET PROPRIÉTÉ INTELLECTUELLE

Les informations contenues dans ce document sont confidentielles et le destinataire ne peut pas les reproduire ni permettre à des tiers de les obtenir, de les utiliser ou de les divulguer sans l'autorisation préalable et expresse de BRICANTEL.

Tous les droits de propriété intellectuelle sur les dessins et modèles présentés sont propriété exclusive de BRICANTEL, et la pratique d'un acte d'exploitation de ceux-ci sans le consentement de cette dernière, selon les termes du code de la propriété industrielle et du code du droit d'auteur et des droits voisins. La violation de l'obligation de confidentialité et / ou des droits de propriété intellectuelle de BRICANTEL peut engager à la responsabilité civile et pénale.

